



Service Kit & Part Reference Guide

2009



Service Kit and Part Reference Guide

Index	Page
Flexible Impeller Pumps	4
Water Pressure Systems	53
Waste Water Handling & Marine Toilets	81
Bilge Pumps	89
Circulating Pumps	93

All pumps are listed in numerical order

Flexible Impeller Pumps

Flexible Impeller Pumps

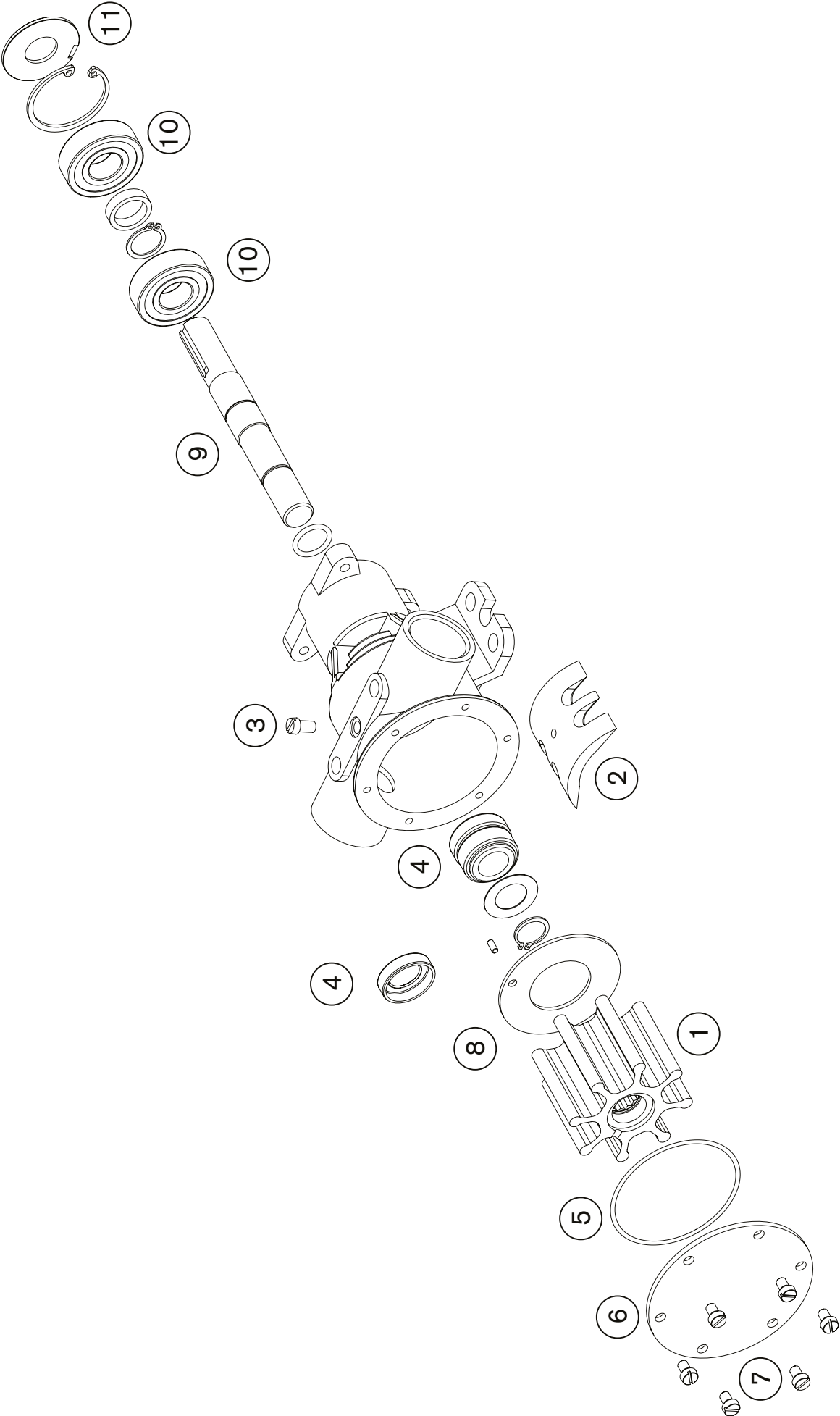

Flexible Impeller Pumps

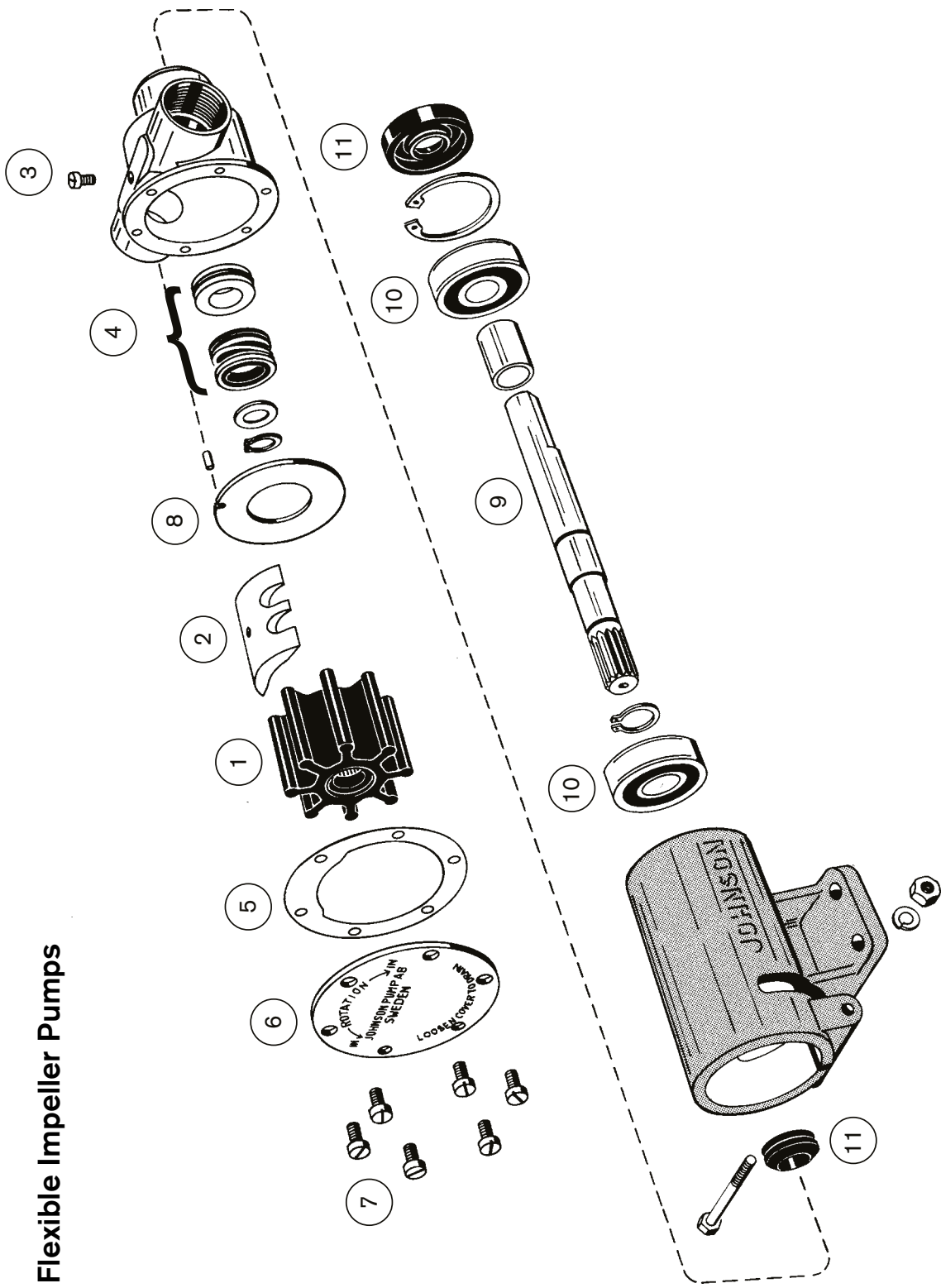

Flexible Impeller Pumps

Part no.	Pump type	Service kit	Impeller	Cam	3	4	5	6	7	8	9	10	11	
				Cam	Camscrew	Seal	Gasket	Endcover	Endcover screw	Wearplate	Shaft	Bearing	Bearing seal	Clutch or Motor
10-11236-2 Obsolete	F7B-903	09-45590	09-1028B*	01-42442	01-46794-07	09-0.2247050	01-42445	01-42441	01-46794-05	01-42443	Obsolete	0.3431.523	Obsolete	-
10-11236-3 Obsolete	F7B-902	09-45590	09-1028B*	01-42584	01-46794-06	09-0.2247050	01-42445	01-42441	01-46794-05	01-42443	Obsolete	0.3431.523	Obsolete	-
10-11246-1 Obsolete	F5B-9	09-45583	09-1027B-1*	01-42397	01-46794-05	09-0.2247050	01-42401	01-42398	01-46794-04	01-42399	Obsolete	0.3431.523	Obsolete	-
10-13021-1	F8B-8	09-45575	09-819B	01-42680	01-46794-02	09-0.2247008	01-42424	01-42422-1	0.0188.134	01-42423	01-35132	0.3431.780	-	-
10-13021-2 Not in production	F8B-89	09-45576	09-819B-9	01-42680	01-46794-02	09-0.2247008	01-42424	01-42422-1	0.0188.134	01-42423	01-35132	0.3431.780	-	-
10-13021-3 Not in production	F8B-803	09-45575	09-819B	01-42425	01-46794-02	09-0.2247008	01-42424	01-42422-1	0.0188.134	01-42423	01-35132	0.3431.780	-	-
10-13021-4 Not in production	F8B-893	09-45576	09-819B-9	01-42425	01-46794-02	09-0.2247008	01-42424	01-42422-1	0.0188.134	01-42423	01-35132	0.3431.780	-	-
10-13021-5 Not in production	F8B-8	09-45577	09-819B	01-42680	01-46794-02	0.2233.015	01-42424	01-42422-1	0.0188.134	01-42423	01-35132	0.3431.780	-	-
10-13021-6 Not in production	F8B-89	09-45578	09-819B-9	01-42680	01-46794-02	0.2233.015	01-42424	01-42422-1	0.0188.134	01-42423	01-35132	0.3431.780	-	-
10-13021-7 Not in production	F8B-803	09-45577	09-819B	01-42425	01-46794-02	0.2233.015	01-42424	01-42422-1	0.0188.134	01-42423	01-35132	0.3431.780	-	-
10-13021-8 Not in production	F8B-893	09-45578	09-819B-9	01-42425	01-46794-02	0.2233.015	01-42424	01-42422-1	0.0188.134	01-42423	01-35132	0.3431.780	-	-
10-13021-9	F8B-8007	09-45575	09-819B	01-42680	01-46794-02	09-0.2247008	01-42424	01-42422-1	0.0188.134	01-42423	01-35132	0.3431.780	-	-
10-13021-10 Not in production	F8B-8907	09-45576	09-819B-9	01-42680	01-46794-02	09-0.2247008	01-42424	01-42422-1	0.0188.134	01-42423	01-35132	0.3431.780	-	-
10-13021-11 Not in production	F8B-8037	09-45575	09-819B	01-42425	01-46794-02	09-0.2247008	01-42424	01-42422-1	0.0188.134	01-42423	01-35132	0.3431.780	-	-
10-13021-12 Not in production	F8B-8937	09-45576	09-819B-9	01-42425	01-46794-02	09-0.2247008	01-42424	01-42422-1	0.0188.134	01-42423	01-35132	0.3431.780	-	-
10-13021-13 Not in production	F8B-8007	09-45577	09-819B	01-42680	01-46794-02	0.2233.015	01-42424	01-42422-1	0.0188.134	01-42423	01-35132	0.3431.780	-	-
10-13021-14 Not in production	F8B-8907	09-45578	09-819B-9	01-42680	01-46794-02	0.2233.015	01-42424	01-42422-1	0.0188.134	01-42423	01-35132	0.3431.780	-	-
10-13021-15 Not in production	F8B-8037	09-45577	09-819B	01-42425	01-46794-02	0.2233.015	01-42424	01-42422-1	0.0188.134	01-42423	01-35132	0.3431.780	-	-

A - parts no. 1, 4, 5, 7 included
front

** - shaft drive end
*** - included in service kit

**** - back

***** -

Flexible Impeller Pumps

Part no.	Pump type	Service kit	Impeller	Cam	3	4	5	6	7	8	9	10	11	Clutch or Motor
A	1	2	Cam	Camscrew	Seal	Gasket	Endcover	Endcover screw	Wearplate	Shaft	Bearing	Bearing seal	Clutch or Motor	
10-13021-16 Not in production	F8B-8937	09-45578	09-819B-9	01-42425	01-46794-02	0.2233.015	01-42424	01-42422-1	0.0138.134	01-42423	01-35132	0.3431.780	-	-
10-13021-17 Obsolete	F8B-8	09-45575	09-819B	01-42680	01-46794-02	09-0.2247.008	01-42424	01-46006	0.0138.134	01-42423	01-35132	0.3431.780	-	-
10-13021-91	F8B-8007	09-45575	09-819B	01-42680	01-46794-02	09-0.2247.008	01-42424	01-42422-1	0.0138.134	01-42423	01-35720	0.3431.780	-	-
10-13021-92 Not in production	F8B-8007	09-45575	09-819B	01-42680	01-46794-02	09-0.2247.008	01-42424	01-42422-1	0.0138.134	01-42423	01-35746	0.3431.780	-	-
10-13021-95	F8B-8007	09-45575	09-819B	01-42680	01-46794-02	09-0.2247.008	01-42424	01-42422-1	0.0138.134	01-42423	01-35746	0.3431.780	-	-
10-13021-96	F8B-8007	09-45575	09-819B	01-42680	01-46794-02	09-0.2247.008	01-42424	01-42422-1	0.0138.134	01-42423	01-35746	0.3431.780	-	-
10-13022-83 Obsolete	F8B-5001	09-45575	09-819B	01-42680	01-46794-02	09-0.2247.008	01-42424	01-46006	0.0138.134	01-42423	01-35136	0.3431.780	-	0.3454.001 = 12V 2xA 0.3454.002 = 24V 2xA 0.3454.003 = 12V 1xB 0.3454.004 = 24V 1xB
10-13022-95	F8B-50017	09-45575	09-819B	01-42680	01-46794-02	09-0.2247.008	01-42424	01-42422-1	0.0138.134	01-42423	01-35136	0.3431.780	-	0.3454.001 = 12V 2xA 0.3454.002 = 24V 2xA 0.3454.003 = 12V 1xB 0.3454.004 = 24V 1xB
10-13022-96	F8B-50017	09-45575	09-819B	01-42680	01-46794-02	09-0.2247.008	01-42424	01-42422-1	0.0138.134	01-42423	01-35136	0.3431.780	-	0.3454.001 = 12V 2xA 0.3454.002 = 24V 2xA 0.3454.003 = 12V 1xB 0.3454.004 = 24V 1xB

A - parts no. 1, 4, 5, 7 included front
* - gasket included
** - shaft drive end
*** - included in service kit
**** - back
***** -

Flexible Impeller Pumps

Part no.	Pump type	Service kit	Impeller	Cam	3	4	5	6	7	8	9	10	11	Clutch or Motor
				Cam	Camscrew	Seal	Gasket	Endcover	Endcover screw	Wearplate	Shaft	Bearing	Bearing seal	
10-13022-98	F8B-50017	09-45575	09-819B	01-42680	01-46794-02	09-0.2247008	01-42424	01-42422-1	0.0138.134	01-42423	01-35136	0.3431.780	-	0.3454.001 = 12V 2xA 0.3454.002 = 24V 2xA 0.3454.003 = 12V 1xB 0.3454.004 = 24V 1xB
10-13022-99	F8B-5001	09-45575	09-819B	01-42680	01-46794-02	09-0.2247008	01-42424	01-42422-1	0.0138.134	01-42423	01-35136	0.3431.780	-	0.3454.001 = 12V 2xA 0.3454.002 = 24V 2xA 0.3454.003 = 12V 1xB 0.3454.004 = 24V 1xB
10-13024-1	F8B-3000	09-45579	09-819B	01-42680	01-46794-02	09-0.2247051	01-42424	01-42422-1	0.0144.200	01-42423	01-35137	0.3431.780	0.2234.337/ 0.2230.319	-
10-13024-2	F8B-3900	09-45580	09-819B-9	01-42680	01-46794-02	09-0.2247051	01-42424	01-42422-1	0.0144.200	01-42423	01-35137	0.3431.780	0.2234.337/ 0.2230.319	-
10-13024-3	F8B-3030	09-45579	09-819B	01-42425	01-46794-02	09-0.2247051	01-42424	01-42422-1	0.0144.200	01-42423	01-35137	0.3431.780	0.2234.337/ 0.2230.319	-
10-13024-4	F8B-3930	09-45580	09-819B-9	01-42425	01-46794-02	09-0.2247051	01-42424	01-42422-1	0.0144.200	01-42423	01-35137	0.3431.780	0.2234.337/ 0.2230.319	-
10-13024-5	F8B-3020	09-45579	09-819B	01-42755	01-46794-08	09-0.2247051	01-42424	01-42422-1	0.0144.200	01-42423	01-35137	0.3431.780	0.2234.337/ 0.2230.319	-
10-13024-6	F8B-3920	09-45580	09-819B-9	01-42755	01-46794-08	09-0.2247051	01-42424	01-42422-1	0.0144.200	01-42423	01-35137	0.3431.780	0.2234.337/ 0.2230.319	-
10-13025-99	F8B-5000	09-45579	09-819B	01-42680	01-46794-02	09-0.2247051	01-42424	01-42422-1	0.0144.200	01-42423	01-35138	0.3431.780	0.2234.337/ 0.2230.319	0.3454.001 = 12V 2xA 0.3454.002 = 24V 2xA 0.3454.003 = 12V 1xB 0.3454.004 = 24V 1xB
10-13026-1	F9B-3000	09-45581	09-802B	01-43137	01-46794-02	09-0.2247051	01-42424	01-42422-1	0.0144.200	01-42423	01-35137	0.3431.780	0.2234.337/ 0.2230.319	-
10-13026-2	F9B-3030	09-45581	09-802B	01-43135	01-46794-02	09-0.2247051	01-42424	01-42422-1	0.0144.200	01-42423	01-35137	0.3431.780	0.2234.337/ 0.2230.319	-
10-13026-3	F9B-3020	09-45581	09-802B	01-43138	01-46794-08	09-0.2247051	01-42424	01-42422-1	0.0144.200	01-42423	01-35137	0.3431.780	0.2234.337/ 0.2230.319	-

A - parts no. 1, 4, 5, 7 included front
 * - gasket included
 ** - shaft drive end
 *** - included in service kit
 **** - back
 ***** -

Flexible Impeller Pumps

Part no.	Pump type	Service kit	Impeller	Cam	3	4	5	6	7	8	9	10	11	Clutch or Motor
				Cam	Camscrew	Seal	Gasket	Endcover	Endcover screw	Wearplate	Shaft	Bearing	Bearing seal	
Not in production													0.2230.319	
10-13026-4	F9B-3600	09-45582	09-814B	01-43137	01-46794-02	09-0.2247051	01-42424	01-42422-1	0.0144.200	01-42423	01-35137	0.3431.780	0.2234.337/	-
Not in production													0.2230.319	
10-13026-5	F9B-3630	09-45582	09-814B	01-43135	01-46794-02	09-0.2247051	01-42424	01-42422-1	0.0144.200	01-42423	01-35137	0.3431.780	0.2234.337/	-
Not in production													0.2230.319	
10-13026-6	F9B-3620	09-45582	09-814B	01-43138	01-46794-08	09-0.2247051	01-42424	01-42422-1	0.0144.200	01-42423	01-35137	0.3431.780	0.2234.337/	-
Not in production													0.2230.319	
10-13026-7	F9B-3007	09-45581	09-802B	01-43137	01-46794-02	09-0.2247051	01-42424	01-42422-1	0.0144.200	01-42423	01-35137	0.3431.780	0.2234.337/	-
Not in production													0.2230.319	
10-13026-8	F9B-3037	09-45581	09-802B	01-43135	01-46794-02	09-0.2247051	01-42424	01-42422-1	0.0144.200	01-42423	01-35137	0.3431.780	0.2234.337/	-
Not in production													0.2230.319	
10-13026-9	F9B-3027	09-45581	09-802B	01-43138	01-46794-08	09-0.2247051	01-42424	01-42422-1	0.0144.200	01-42423	01-35137	0.3431.780	0.2234.337/	-
Not in production													0.2230.319	
10-13026-10	F9B-3607	09-45582	09-814B	01-43137	01-46794-02	09-0.2247051	01-42424	01-42422-1	0.0144.200	01-42423	01-35137	0.3431.780	0.2234.337/	-
Not in production													0.2230.319	
10-13026-11	F9B-3637	09-45582	09-814B	01-43135	01-46794-02	09-0.2247051	01-42424	01-42422-1	0.0144.200	01-42423	01-35137	0.3431.780	0.2234.337/	-
Not in production													0.2230.319	
10-13026-12	F9B-3627	09-45582	09-814B	01-43138	01-46794-08	09-0.2247051	01-42424	01-42422-1	0.0144.200	01-42423	01-35137	0.3431.780	0.2234.337/	-
Not in production													0.2230.319	
10-13027-63	F9B-5600	09-45582	09-814B	01-43137	01-46794-02	09-0.2247051	01-42424	01-42422-1	0.0144.200	01-42423	01-35138	0.3431.780	0.2230.319	0.3454.001 = 12V 2xA 0.3454.002 = 24V 2xA 0.3454.003 = 12V 1xB 0.3454.004 = 24V 1xB
Obsolete													0.2230.319	
10-13027-98	F9B-5607	09-45582	09-814B	01-43137	01-46794-02	09-0.2247051	01-42424	01-42422-1	0.0144.200	01-42423	01-35138	0.3431.780	0.2230.319	0.3454.001 = 12V 2xA 0.3454.002 = 24V 2xA 0.3454.003 = 12V 1xB 0.3454.004 = 24V 1xB
10-13027-99	F9B-5600	09-45582	09-814B	01-43137	01-46794-02	09-0.2247051	01-42424	01-42422-1	0.0144.200	01-42423	01-35138	0.3431.780	0.2230.319	0.3454.001

A - parts no. 1, 4, 5, 7 included front * - gasket included ** - shaft drive end *** - included in service kit **** - back ***** -

Flexible Impeller Pumps

Part no.	Pump type	Service kit	Impeller	Cam	3	4	5	6	7	8	9	10	11	Clutch or Motor
					Camscrew	Seal	Gasket	Endcover	Endcover screw	Wearplate	Shaft	Bearing	Bearing seal	
10-13064-1	F9B/F7B-9	09-46646-1	09-802B	01-43137	01-46794-02	09-0.2247051	01-42424	-	0.0148.001	01-42423	01-35214	0.3431.701	0.2233.016	-
Customer branded			09-1028B*	01-42679	01-46794-01	01-45758	01-45758			01-42443				= 12V 2xA 0.3454.002 = 24V 2xA
10-13064-2	F9B/F7B-9	09-46646-1	09-802B	01-43137	01-46794-02	09-0.2247051	01-42424	-	0.0148.001	01-42423	01-35214	0.3431.701	0.2233.016	-
			09-1028B*	01-42679	01-46794-01	01-45758	01-45758			01-42443				= 0.3454.003 = 12V 1xB 0.3454.004 = 24V 1xB
10-13080-01	F9B-9	09-45582	09-814B	01-45173	01-46794-09	09-0.2247051	0.2173.459	01-45961	0.0198.134	01-42423	01-35276	0.3431.746	0.2233.002	-
10-13087-01	F9B-905	09-45582	09-814B	01-45018	01-46794-02	09-0.2247051	01-42424	01-42422-1	0.0144.003	01-42423	01-35298	0.3431.486	0.2233.002	-
Obsolete, repl. by 10-13166-01														
10-13088-01	F8B-9	09-45579	09-819B	01-42680	01-46794-02	09-0.2247051	01-42424	01-42422-1	0.0144.200	01-42423	01-35294	0.3431.746	-	-
10-13088-02	F8B-902	09-45579	09-819B	01-42755	01-46794-08	09-0.2247051	01-42424	01-42422-1	0.0144.200	01-42423	01-35294	0.3431.746	-	-
Not in production														
10-13088-03	F8B-903	09-45579	09-819B	01-42425	01-46794-02	09-0.2247051	01-42424	01-42422-1	0.0144.200	01-42423	01-35294	0.3431.746	-	-
10-13095-01	F9B-9	09-45582	09-814B	01-43137	01-46794-02	09-0.2247051	01-42424	01-42422-1	0.0144.200	01-42423	01-35212	0.3431.684	0.2233.016	-
10-13095-02	F9B-9	09-45582	09-814B	01-43137	01-46794-02	09-0.2247051	01-42424	01-42422-1	0.0144.200	01-42423	01-35212	0.3431.684	0.2233.016	-
10-13096-01	F8B-9	09-45579	09-819B	01-42680	01-46794-02	09-0.2247051	01-42424	01-42422-1	0.0144.200	01-42423	01-35212	0.3431.684	0.2233.016	-
10-13096-02	F8B-9	09-45579	09-819B	01-42680	01-46794-02	09-0.2247051	01-42424	01-42422-1	0.0144.200	01-42423	01-35212	0.3431.684	0.2233.016	-
10-13121-01	F95B-3000	09-46371	09-820B	01-35744	01-46794-09	09-0.2247018	0.2172.142	01-35284-2	0.0138.134	01-42423	01-35694	0.3431.743/ 0.3431.043**	0.2233.008/ 0.2230.322	-
10-13121-02	F95B-3030	09-46371	09-820B	Obsolete	01-46794-11	09-0.2247018	01-45354	01-35284	0.0138.134	01-42423	01-35694	0.3431.743/ 0.3431.043**	0.2233.008/ 0.2230.322	-
Not in production														
10-13121-03	F95B-3020	09-46371	09-820B	Obsolete	01-46794-11	09-0.2247018	01-45354	01-35284	0.0138.134	01-42423	01-35694	0.3431.743/ 0.3431.043**	0.2233.008/ 0.2230.322	-
Not in production														
10-13121-04	F95B-3007	09-46371	09-820B	01-35744	01-46794-09	09-0.2247018	0.2172.142	01-35284-2	0.0138.134	01-42423	01-35694	0.3431.743/ 0.3431.043**	0.2233.008/ 0.2230.322	-
10-13141-01	F75B-9	09-46365	09-821B	01-46146	01-46794-12	09-0.2247008	01-46286	01-46285	01-46794-12	01-42443	01-35703	0.3431.001/ 0.3431.044	0.2233.351	-
Customer branded														
10-13141-02	F75B-9	09-46365	09-821B	01-46146	01-46794-12	09-0.2247008	01-46286	01-46285	01-46794-12	01-42443	01-35703	0.3431.001/ 0.3431.044	0.2233.351	-

A - parts no. 1, 4, 5, 7 included front
 * - gasket included
 ** - shaft drive end
 *** - included in service kit
 **** - back
 ***** -

Flexible Impeller Pumps

Part no.	Pump type	Service kit	Impeller	Cam	Camscrew	Seal	Gasket	Endcover	Endcover screw	Wearplate	Shaft	Bearing	Bearing seal	Clutch or Motor
A	1	2	3	4	5	6	7	8	9	10	11			
10-13142-01 Customer branded	F75B/F7B-9	09-46366	09-821B 09-1028B*	01-46146 01-42679	01-46794-12 01-46794-01	09-0.2247008	01-46286 01-46362	-	0.0138.921	01-42443	01-35702	0.3431.001/ 0.3431.044	0.2233.351	-
10-13142-02	F75B/F7B-9	09-46366	09-821B 09-1028B*	01-46146 01-42679	01-46794-12 01-46794-01	09-0.2247008	01-46286 01-46362	-	0.0138.921	01-42443	01-35702	0.3431.001/ 0.3431.044	0.2233.351	-
10-13143-98	F95B-5007	09-46371	09-820B	01-35744	01-46794-09	09-0.2247018	0.2172.142	01-35284-2	0.0138.134	01-42423	01-35700	0.3431.743/ 0.3431.043**	0.2230.322	0.3454.001 = 12V 2xA 0.3454.002 = 24V 2xA 0.3454.003 = 12V 1xB 0.3454.004 = 24V 1xB
10-13143-99	F95B-5000	09-46371	09-820B	01-35744	01-46794-09	09-0.2247018	0.2172.142	01-35284-2	0.0138.134	01-42423	01-35700	0.3431.743/ 0.3431.043**	0.2230.322	0.3454.001 = 12V 2xA 0.3454.002 = 24V 2xA 0.3454.003 = 12V 1xB 0.3454.004 = 24V 1xB
10-13145-01 Obsolete	F9B-9	-	09-802B	01-43137	01-46794-02	09-0.2247051	0.2172.142	Cust.brand.	0.0138.134	01-42423	01-35870	0.3431.486	0.2234.001	-
10-13153-01 Obsolete, repl. by 10-13265-01	F75B-9	09-46691	09-821B	01-46146	01-46794-12	09-0.2247008	01-46286	Cust.brand.	0.0141.502	01-42443	01-35728	0.3431.665	0.2233.008	-
10-13159-01 Obsolete	F5B-905	-	09-1027B-1*	01-46474	01-46794-12	0.2233.001	01-46473	Cust.brand.	0.0141.502	-	-	0.3431.761	-	-
10-13159-02 Obsolete	F5B-905	-	09-1027B-1*	01-46474	01-46794-12	0.2233.001	01-46473	Cust.brand.	0.0141.502	-	-	0.3431.761	-	-
10-13159-03 Obsolete	F5B-905	-	09-1027B-1*	01-46474	01-46794-12	0.2233.001	01-46473	Cust.brand.	0.0141.502	-	-	0.3431.761	-	-
10-13159-04 Obsolete	F5B-905	-	09-1027B-1*	01-46474	01-46794-12	0.2233.001	01-46473	Cust.brand.	0.0141.502	-	-	0.3431.761	-	-

A - parts no. 1, 4, 5, 7 included front * - gasket included ** - shaft drive end *** - included in service kit **** - back ***** -

Flexible Impeller Pumps

Part no.	Pump type	Service kit	Impeller	Cam	3	4	5	6	7	8	9	10	11	Clutch or Motor
A			1	2	Camscrew	Seal	Gasket	Endcover	Endcover screw	Wearplate	Shaft	Bearing	Bearing seal	
10-13159-05 Obsolete	F5B-905	-	09-1027B-1*	01-46474	01-46794-12	0.2233.001	01-46473	Cust.brand.	0.0141.502	-	-	0.3431.761	-	-
10-13159-06 Obsolete	F5B-905	-	09-1027B-1*	01-46474	01-46794-12	0.2233.001	01-46473	Cust.brand.	0.0141.502	-	-	0.3431.761	-	-
10-13159-07 Customer branded	F5B-905	-	09-1027B-1*	01-46706	-	0.2233.001	0.2173.471	Cust.brand.	0.0141.502	-	01-46475	0.3431.761	-	-
10-13159-08 Customer branded	F5B-905	-	09-1027B-1*	01-46706	-	0.2233.001	0.2173.471	Cust.brand.	0.0141.502	-	01-46475	0.3431.761	-	-
10-13165-01 Customer branded	F95B-9	09-46599-1	09-820B	01-35744	01-46794-09	09-0.2247.018	0.2172.142	01-35773-2	0.0138.134	01-42423	01-35743	0.3428.516	0.2234.502	-
10-13165-02	F95B-9	09-46599-1	09-820B	01-35744	01-46794-09	09-0.2247.018	0.2172.142	01-35773-2	0.0138.134	01-42423	01-35743	0.3428.516	0.2234.502	-
10-13166-01 Customer branded	F9B-905	09-45582	09-814B	01-45018	01-46794-02	09-0.2247.051	01-42424	01-42422-1	0.0144.003	01-42423	01-35742	0.3431.486	0.2233.002	-
10-13170-01 Customer branded	F75B-9	-	09-821B	01-46146	01-46794-12	09-0.2247.008	0.2173.493	01-46285	01-46794-12	01-42443	01-35771	0.3431.485	0.2233.008	-
10-13171-01 Customer branded	F9B-905	-	09-814B	01-45172	01-46794-09	09-0.2247.051	0.2172.142	01-42422-1	0.0138.134	01-46538	01-35833	0.3431.780	0.2230.319	-
10-13175-01	F8B-3000- TSS	09-45579	09-819B	01-42680	01-46794-02	09-0.2247.051	01-42424	01-42422-1	0.0144.200	01-42423	01-35137	0.3431.780	0.2230.319	-
10-13176-99	F8B-5000- TSS	09-45579	09-819B	01-42680	01-46794-02	09-0.2247.051	01-42424	01-42422-1	0.0144.200	01-42423	01-35138	0.3431.780	0.2234.337/ 0.2230.319	0.3454.001 = 12V 2xA 0.3454.002 = 24V 2xA 0.3454.003 = 12V 1xB 0.3454.004 = 24V 1xB
10-13177-01	F9B-3000- TSS	09-45581	09-802B	01-43137	01-46794-02	09-0.2247.051	01-42424	01-42422-1	0.0144.200	01-42423	01-35137	0.3431.780	0.2234.337/ 0.2230.319	-
10-13178-99	F9B-5600- TSS	09-45582	09-814B	01-43137	01-46794-02	09-0.2247.051	01-42424	01-42422-1	0.0144.200	01-42423	01-35137	0.3431.780	0.2230.319	0.3454.001 = 12V 2xA 0.3454.002 = 24V 2xA 0.3454.003 = 12V 1xB 0.3454.004 = 24V 1xB

A - parts no. 1, 4, 5, 7 included front
 * - gasket included
 ** - shaft drive end
 *** - included in service kit
 **** - back
 ***** -

Flexible Impeller Pumps

Part no.	Pump type	Service kit	Impeller	Cam	3	4	5	6	7	8	9	10	11	Clutch or Motor
A					Camscrew	Seal	Gasket	Endcover	Endcover screw	Wearplate	Shaft	Bearing	Bearing seal	
10-13180-01 Obsolete, repl. by 10-13263-01	F8B-9	09-46692	09-819B	01-42680	01-46794-02	09-0.2247008	0.2172.142	01-42422-1	0.0138.134	01-42423	01-35796	0.3431.525	0.2234.010	-
10-13208-01 Customer branded	F6B-9	-	09-812B-1**	-	-	0.2233.001	0.2173.475	01-46556	0.0279.301	-	01-46669	0.3431.742	-	-
10-13208-02 Customer branded	F6B-9	-	09-812B-1**	-	-	0.2233.001	0.2173.475	01-46556	0.0279.301	-	01-46669	0.3431.742	-	-
10-13223-01 Obsolete	F5B-9	-	09-1027B-1*	-	-	0.2233.001	0.2173.476	-	0.0141.501	-	-	0.3431.753	-	-
10-13223-02 Obsolete	F5B-9	-	09-1027B-1*	-	-	0.2233.001	0.2173.476	-	0.0141.501	-	-	0.3431.753	-	-
10-13223-03 Obsolete	F5B-9	-	09-1027B-1*	-	-	0.2233.001	0.2173.476	-	0.0141.501	-	-	0.3431.753	-	-
10-13223-04 Obsolete	F5B-9	-	09-1027B-1*	-	-	0.2233.001	0.2173.476	-	0.0141.501	-	-	0.3431.753	-	-
10-13225-01	F9B-3000-VF	09-45581	09-802B	01-43137	01-46794-02	09-0.2247051	0.2172.142	01-42422-3 (o-ring)	0.0144.200	01-42423	01-35137	0.3431.780	0.2234.337	-
10-13226-99	F9B-5600-VF	09-45581	09-814B	01-43137	01-46794-02	09-0.2247051	0.2172.142	01-42422-3	0.0144.200	01-42423	01-35138	0.3431.780	0.2230.319	0.3454.001 = 12V 2xA 0.3454.002 = 24V 2xA 0.3454.003 = 12V 1xB 0.3454.004 = 24V 1xB
10-13234-01 Customer branded	F8B-9	-	09-1029B	01-42680	01-46794-02	09-0.2247051	01-42424	01-42422-1	0.0144.002	01-42423	01-35868	0.3431.684	0.2233.016	-
10-13236-01 Obsolete	F5B-9	-	09-1027B-1*	-	-	0.2233.001	0.2173.476	-	0.0141.501	-	-	0.3431.753	-	-
10-13236-02 Obsolete	F5B-9	-	09-1027B-1*	-	-	0.2233.001	0.2173.476	-	0.0141.501	-	-	0.3431.753	-	-
10-13243-01 Customer branded	F95B-9	-	09-820B	01-35883	01-46794-09	09-0.2247018	0.2172.142	01-35773-2	0.0138.134	01-46538	01-35872	0.3431.743 0.3431.043	0.2234.010	-
10-13248-01 Customer branded	F95B-9	-	09-820B	01-35744	01-46794-09	09-0.2247018	0.2172.142	01-35773-2	0.0138.134	01-46538	01-35892	0.3428.515 0.3431.745	0.2234.502	-
10-13248-02 Customer branded	F95B-903	-	09-820B	01-35854	01-46794-09	09-0.2247018	0.2172.142	01-35773-2	0.0138.134	01-46538	01-35892	0.3428.515 0.3431.745	0.2234.502	-
10-13260-01 Customer branded	F8B-9	-	09-1029B	01-45771	01-46794-02	0.2233.250	01-45354	01-35284	0.0138.134	01-42423	01-46822	0.3431.760	0.2233.250	-

A - parts no. 1, 4, 5, 7 included front * - gasket included ** - shaft drive end *** - included in service kit **** - back ***** -

Flexible Impeller Pumps

Part no.	Pump type	Service kit	Impeller	Cam	3	4	5	6	7	8	9	10	11	Clutch or Motor
A				2	Camscrew	Seal	Gasket	Endcover	Endcover screw	Wearplate	Shaft	Bearing	Bearing seal	
10-13263-01 Customer branded	F8B-9	-	09-819B	01-42680	01-46794-02	09-0.2247008	0.2172.142	Cust. branded	0.0138.134	01-42423	01-35910	0.3431.525	0.2234.010	
10-13265-01 Obsolete, repl by 10-13306-01	F75B-9	-	09-821B	01-46146	01-46794-12	09-0.2247008	01-46286	Cust. branded	0.0141.502	01-42443	01-35911	0.3431.030	0.2233.008	
10-13283-01	F5B-9	-	09-1027B-1*	-	-	0.2233.252	0.2173.475	Cust. branded	0.0141.502	01-46532-2	01-46896	0.3431.755	0.2234.015	
10-13283-1 Obsolete, repl by 10-13283-01	F5B-9	-	09-1027B-1*	-	-	0.2233.252	0.2173.475	Cust. branded	0.0141.502	01-46532-2	01-46896	0.3431.755	0.2234.015	
10-13286-01 Customer branded	F75B-9	-	09-821B	01-46146	01-46794-12	09-0.2247008	0.2172.996	Cust. branded	0.0141.503	01-42443	01-35998	0.3431.485	0.2233.008	
10-13305-01 Customer branded	F8B-9	-	09-819B	01-42680	01-46794-02	09-0.2247008	0.2172.142	Cust. branded	0.0138.134	01-42423	01-35910	0.3431.525	0.2234.010	
10-13306-01 Customer branded	F75B-9	-	09-821B	01-46146	01-46794-12	09-0.2247008	01-46286	Cust. branded	0.0141.502	01-42443	01-35911	0.3431.030	0.2233.008	
10-13324-01 Customer branded, repl by 10-13353-01	F5B-9	-	09-1027B-1*	-	-	0.2233.001	0.2173.476	-	-	-	-	0.3431.753	-	
10-13324-02 Customer branded, repl by 10-13353-02	F5B-9	-	09-1027B-1*	-	-	0.2233.001	0.2173.476	-	-	-	-	0.3431.753	-	
10-13324-03 Customer branded, repl by 10-13353-03	F5B-9	-	09-1027B-1*	-	-	0.2233.001	0.2173.476	-	-	-	-	0.3431.753	-	
10-13324-04 Customer branded, repl by 10-13353-04	F5B-9	-	09-1027B-1*	-	-	0.2233.001	0.2173.476	-	-	-	-	0.3431.753	-	
10-13325-01 Customer branded, repl by 10-13354-01	F5B-9	-	09-1027B-1*	-	-	0.2233.001	0.2173.476	-	-	-	-	0.3431.753	-	
10-13325-02 Customer branded, repl by 10-13354-02	F5B-9	-	09-1027B-1*	-	-	0.2233.001	0.2173.476	-	-	-	-	0.3431.753	-	
10-13328-01 Customer branded	F5B-9	-	09-1027B-1*	-	-	09-0.2247050	0.2173.475	01-46535	0.0138.987	01-46532	01-46531	0.3431.483	-	
10-13328-02 Customer branded	F5B-9	-	09-1027B-1*	-	-	09-0.2247050	0.2173.475	01-46535	0.0138.987	01-46532	01-46531	0.3431.483	-	
10-13331-01 Customer branded, replaced by 0-13432-01	F6B-9	-	09-812B-1*-1*	-	-	0.2233.001	0.2173.475	01-36007	0.0141.503	-	-	0.3431.742	-	0.3431.749
10-13333-01 Customer branded	F6B-9	-	09-812B-1*-1*	01-46502	0.0279.033	09-0.2247022	0.2173.475	01-46556	0.0141.502	01-42399-2	01-36010	0.3431.778	0.2233.405	

A - parts no. 1, 4, 5, 7 included front
 * - gasket included
 ** - shaft drive end
 *** - included in service kit
 **** - back
 ***** -

Flexible Impeller Pumps

Part no.	Pump type	Service kit	Impeller	Cam	Cam screw	Seal	Gasket	Endcover	7 Endcover screw	8 Wearplate	9 Shaft	10 Bearing	11 Bearing seal	Clutch or Motor
10-13337-01 Customer branded	F4B-903	-	09-810B-1*	-	-	0.2233.010	0.2173.476	01-42398	0.0141.700	-	01-46541	0.3431.760 0.3431.748	-	-
10-13338-01	F95B-9	-	01-95744	0.0252.189	0.0252.189	09-0.2247.018	0.2172.142	01-35284-2	0.0138.134	01-42423	01-36018	0.3431.745 0.3428.515	-	-
10-13344-01 Customer branded	F5B-905	-	09-1027B-1*	01-46706	0.0141.502	0.2233.001	01-46540	Cust.branded	0.0141.502	-	-	0.3431.761	-	-
10-13345-01 Customer branded	F6B-9	-	09-812B-1*-1*	-	-	0.2233.001	0.2173.475	01-46556	0.0141.503	-	-	0.3431.742	-	-
10-13353-01 Customer branded	F5B-9	-	09-1027B-1*	-	-	0.2233.001	0.2173.476	-	-	-	-	0.3431.753	-	-
10-13353-02 Customer branded	F5B-9	-	09-1027B-1*	-	-	0.2233.001	0.2173.476	-	-	-	-	0.3431.753	-	-
10-13353-03 Customer branded	F5B-9	-	09-1027B-1*	-	-	0.2233.001	0.2173.476	-	-	-	-	0.3431.753	-	-
10-13353-04 Customer branded	F5B-9	-	09-1027B-1*	-	-	0.2233.001	0.2173.476	-	-	-	-	0.3431.753	-	-
10-13354-01 Customer branded	F5B-9	-	09-1027B-1*	-	-	0.2233.001	0.2173.476	-	-	-	-	0.3431.753	-	-
10-13354-02 Customer branded	F5B-9	-	09-1027B-1*	-	-	0.2233.001	0.2173.476	-	-	-	-	0.3431.753	-	-
10-13356-01 Customer branded	F6B-9	-	09-812B-1*-1*	-	-	0.2233.001	0.2173.476	-	-	-	-	0.3431.753	-	-
10-13356-03 Customer branded	F6B-9	-	09-812B-1*-1*	-	-	0.2233.001	0.2173.476	-	-	-	-	0.3431.753	-	-
10-13356-04 Customer branded	F6B-9	-	09-812B-1*-1*	-	-	0.2233.001	0.2173.476	-	-	-	-	0.3431.753	-	-
10-13357-01 Customer branded	F6B-9	-	09-812B-1*-1*	-	-	0.2233.001	0.2173.476	-	-	-	-	0.3431.753	-	-
10-13374-01 Customer branded	F7B-9	-	09-1028B	-	-	09-0.2247.022	0.2172.012	-	-	-	-	0.3431.742	-	-
10-13376-01 Customer Branded	F6B-9	-	09-812B-1*-1*	-	-	09-0.2247.022	0.2173.475	01-46556	0.0141.502	01-46969	01-46964	0.3431.778	0.2234.016	-
10-13377-01 Customer Branded	F98B-9	-	09-842B???	01-96062	0.0252.189	09-0.2247.018	0.2172.142	01-35773-2	0.0138.134	01-42423	01-36061	0.3428.516	-	-

A - parts no. 1, 4, 5, 7 included front * - gasket included ** - shaft drive end *** - included in service kit **** - back ***** -

Flexible Impeller Pumps

Part no.	Pump type	Service kit	Impeller	Cam	3	4	5	6	7	8	9	10	11
					Camscrew	Seal	Gasket	Endcover	Endcover screw	Wearplate	Shaft	Bearing	Bearing seal
10-13392-01 Customer Branded	F5B-9	-	09-1027B-1*	01-45976	01-46794-05	0.2233.001	01-42401	01-46007	0.0279.500	01-42399	01-47217	0.3431.761	-
10-13392-02 Customer Branded	F5B-9	-	09-1027B-1*	01-45976	01-46794-05	0.2233.001	01-42401	01-46007	0.0279.500	01-42399	01-47217	0.3431.761	-
10-13432-01 Customer Branded	F6B-9	-	09-812B-1*-1*	-	-	0.2233.001	0.2173.475	Cust.branded	0.0141.503	-	-	0.3431.779	-
10-21876-1 Obsolète	F7B-9	09-45590	09-1028B*	01-42679	01-46794-07	09-0.2247.050	01-42400	01-42441	01-46794-05	01-42443	01-31964	0.3431.486	0.2233.002
10-21876-2	F7B-903	09-45590	09-1028B*	01-42442	01-46794-07	09-0.2247.050	01-42400	01-42441	01-46794-05	01-42443	01-31964	0.3431.486	0.2233.002
10-21915-1 Customer branded	F8B-903	09-45579	09-1029B	01-42425	01-46794-02	09-0.2247.051	01-42424	01-42422-1	0.0144.200	01-42423	01-32020	0.3431.486	0.2233.002
10-21915-2	F8B-903	09-45579	09-819B	01-42425	01-46794-02	09-0.2247.051	01-42424	01-42422-1	0.0144.200	01-42423	01-32020	0.3431.486	0.2233.002
10-22044-1 Obsolète, repl. by 10-24210-1	F5B-3	09-45583	09-1027B-1*	01-42397	01-46794-05	09-0.2247.050	01-42401	01-42398	01-46794-04	01-42399	Obsolète	0.3431.482	0.2233.001/ Obsolète
10-22044-2 Obsolète, repl. by 10-24210-3	F5B-302	09-45583	09-1027B-1*	01-45014	0.0279.032	09-0.2247.050	01-42401	01-42398	01-46794-04	01-42399	Obsolète	0.3431.482	0.2233.001/ Obsolète
10-22044-3 Obsolète, repl. by 10-24210-2	F5B-39	09-45584	09-1027B-9	01-42397	01-46794-05	09-0.2247.050	01-42401	01-42398	01-46794-04	01-42399	Obsolète	0.3431.482	0.2233.001/ Obsolète
10-22044-4 Obsolète, repl. by 10-24210-4	F5B-392	09-45584	09-1027B-9	01-45014	0.0279.032	09-0.2247.050	01-42401	01-42398	01-46794-04	01-42399	Obsolète	0.3431.482	0.2233.001/ Obsolète
10-22045-1 Obsolète, repl. by 10-24209-1	F7B-3	09-45590	09-1028B*	01-42679	01-46794-01	09-0.2247.050	01-42445	01-42441	01-46794-05	01-42443	Obsolète	0.3431.484	0.2233.001/ Obsolète
10-22045-2 Obsolète, repl. by 10-24209-2	F7B-39	09-45591	09-1028B-9	01-42679	01-46794-01	09-0.2247.050	01-42445	01-42441	01-46794-05	01-42443	Obsolète	0.3431.484	0.2233.001/ Obsolète
10-22045-3 Obsolète, repl. by 10-24209-3	F7B-303	09-45590	01-42442	01-42442	01-46794-07	09-0.2247.050	01-42445	01-42441	01-46794-05	01-42443	Obsolète	0.3431.484	0.2233.001/ Obsolète
10-22045-4 Obsolète, repl. by 10-24209-4	F7B-393	09-45591	09-1028B-9	01-42442	01-46794-07	09-0.2247.050	01-42445	01-42441	01-46794-05	01-42443	Obsolète	0.3431.484	0.2233.001/ Obsolète
10-22047-1 Obsolète, repl. by 10-13024-1	F8B-3	09-45579	09-819B	01-42680	01-46794-02	09-0.2247.051	01-42424	01-42422-1	0.0144.003	01-42423	Obsolète	0.3431.486	0.2233.004/ 0.2233.002
10-22047-2 Obsolète, repl. by 10-13024-2	F8B-39	-	09-819B-9	01-42680	01-46794-02	09-0.2247.051	01-42424	01-42422-1	0.0144.003	01-42423	Obsolète	0.3431.486	0.2233.004/ 0.2233.002
10-22047-3 Obsolète, repl. by 10-13024-3	F8B-303	09-45579	09-819B	01-42425	01-46794-02	09-0.2247.051	01-42424	01-42422-1	0.0144.003	01-42423	Obsolète	0.3431.486	0.2233.004/ 0.2233.002

A - parts no. 1, 4, 5, 7 included front * - gasket included ** - shaft drive end *** - included in service kit **** - back ***** -

Flexible Impeller Pumps

Part no.	Pump type	Service kit	Impeller	Cam	3	4	5	6	7	8	9	10	11	Clutch or Motor
				Cam	Camscrew	Seal	Gasket	Endcover	Endcover screw	Wearplate	Shaft	Bearing	Bearing seal	
10-22047-4 Obsolete, repl. by 10-13024-4	F8B-393	-	09-819B-9	01-42425	01-46794-02	09-0.2247051	01-42424	01-42422-1	0.0144.003	01-42423	01-32185 Obsolete	0.3431.486	0.2233.004/ 0.2233.002	-
10-22054-1 Obsolete	F7B-3	09-45590	09-1028B*	01-42679	01-46794-01	09-0.2247050	01-42445	01-42441	01-46794-05	01-42443	Obsolete	0.3431.484	0.2233.001	-
10-22055-1 Obsolete, repl. by 10-24074-1	F4B/6-M	-	09-1026B-1*	01-42389	01-46794-04	Obsolete	01-42391	01-42398	0.0279.501	-	Obsolete	-	-	-
10-22096-1	F8B-900	09-45579	09-819B	01-42680	01-46794-02	09-0.2247051	01-42424	01-42422-1	0.0144.003	01-42423	01-32253	0.3431.486	0.2233.002	-
10-22096-2 Obsolete	F8B-903	09-45579	09-819B	01-42425	01-46794-02	09-0.2247051	01-42424	01-42422-1	0.0144.003	01-42423	01-32253	0.3431.486	0.2233.002	-
10-22096-3	F8B-902	09-45579	09-819B	01-42755	01-46794-08	09-0.2247051	01-42424	01-42422-1	0.0144.003	01-42423	01-32253	0.3431.486	0.2233.002	-
10-22139-1 Obsolete	F7B-903	09-45590	09-1028B*	01-42442	01-46794-07	09-0.2247050	01-42445	01-42441	01-46794-05	01-42443	Obsolete	0.3431.523	Obsolete	-
10-22143-1 Obsolete, repl. by 10-24140-1	F5B-9	09-45583	09-1027B-1*	01-42397	01-46794-05	09-0.2247050	01-42401	01-42398	01-46794-04	01-42399	Obsolete	0.3431.484	0.2233.350	-
10-22143-2 Obsolete, repl. by 10-24140-2	F5B-902	09-45583	09-1027B-1*	01-45014	0.0279.032	09-0.2247050	01-42401	01-42398	01-46794-04	01-42399	Obsolete	0.3431.484	0.2233.350	-
10-22144-1 Obsolete	F7B-9	09-45590	09-1028B*	01-42679	01-46794-01	09-0.2247050	01-42445	01-42441	01-46794-05	01-42443	Obsolete	0.3431.523	0.2233.350	-
10-22147-1 Obsolete	F7B-903	09-45590	09-1028B*	01-42442	01-46794-07	09-0.2247050	01-42445	01-42441	01-46794-05	01-42443	01-31964	0.3431.486	0.2233.002	-
10-22160-1 Obsolete, repl. by 10-24074-1	F4B-4	-	09-1026B-1*	01-42389	01-46794-04	Obsolete	01-42391	01-42398	0.0279.501	-	Obsolete	0.3431.754	-	-
10-22162- Obsolete, repl. by 10-13025-	F8B-5	09-45579	09-819B	01-42680	01-46794-02	09-0.2247051	01-42424	01-42422-1	0.0144.003	01-42423	Obsolete	0.3431.486	0.2234.337/ 0.3454.001 = 12V 2xA 0.3454.002 = 24V 2xA 0.3454.003 = 12V 1xB 0.3454.004 = 24V 1xB	-
10-22335-2 Customer branded	F7B-903	09-45590	09-1028B*	01-42679	01-46794-07	09-0.2247050	01-42445	01-42441	01-46794-05	01-42443	01-31964	0.3431.486	0.2233.002	-
10-22335-3	F7B-9	09-45590	09-1028B*	01-42679	01-46794-07	09-0.2247050	01-42445	01-42441	01-46794-05	01-42443	01-31964	0.3431.486	0.2233.002	-
10-22335-4 Obsolete	F7B-903	09-45590	09-1028B*	01-42442	01-46794-07	09-0.2247050	01-42445	01-42441	01-46794-05	01-42443	01-31964	0.3431.486	0.2233.002	-

A - parts no. 1, 4, 5, 7 included front * - gasket included ** - shaft drive end *** - included in service kit **** - back ***** -

Flexible Impeller Pumps

Part no.	Pump type	Service kit	Impeller	Cam	3	4	5	6	7	8	9	10	11	Clutch or Motor
					Camscrew	Seal	Gasket	Endcover	Endcover screw	Wearplate	Shaft	Bearing	Bearing seal	
10-22342- Obsolete, repl. by 10-24116-	F7B-5	09-45590	09-1028B*	01-42679	01-46794-01	09-0.2247050	01-42445	01-42441	01-46794-05	01-42443	Obsolete	0.3431.484	0.2233.001/	0.3454.001 = 12V 2xA 0.3454.002 = 24V 2xA 0.3454.003 = 12V 1xB 0.3454.004 = 24V 1xB
10-22346-1 Obsolete, repl. by 10-13026-1	F9B-3	09-45581	09-802B	01-43137	01-46794-02	09-0.2247051	01-42424	01-42422-1	0.0144.003	01-42423	Obsolete	0.3431.486	0.2233.337/	-
10-22346-2 Obsolete, repl. by 10-13026-2	F9B-303	09-45581	09-802B	01-43135	01-46794-02	09-0.2247051	01-42424	01-42422-1	0.0144.003	01-42423	Obsolete	0.3431.486	0.2233.002	-
10-22352-1/2 Obsolete, repl. by 10-24182-1/-2	F3B-12/24V	09-45595	09-1052S-9*	Obsolete	0.0279.500	0.2233.007	01-43142	01-43141	0.0279.501	-	-	-	-	Obsolete
10-22353-1/2 Obsolete	F3P10-12/ 24V	-	09-1052S-9*	-	-	0.2233.007	Obsolete	Obsolete	0.0279.500	-	-	-	-	Obsolete
10-22354-1 Obsolete, repl. by 10-24139-1	F7B-9	09-45590	09-1028B*	01-42679	01-46794-01	09-0.2247050	01-42445	01-42441	01-46794-05	01-42443	Obsolete	0.3431.484	0.2233.350	-
10-22354-2 Obsolete, repl. by 10-24139-2	F7B-903	09-45590	09-1028B*	01-42442	01-46794-07	09-0.2247050	01-42445	01-42441	01-46794-05	01-42443	Obsolete	0.3431.484	0.2233.350	-
10-22355-1 Obsolete	F5B-9	09-45583	09-1027B-1*	01-42397	01-46794-05	09-0.2247050	01-42401	01-42398	01-46794-04	01-42399	Obsolete	0.3431.484	0.2233.350	-
10-22355-2 Obsolete	F5B-902	09-45583	09-1027B-1*	01-45014	0.0279.032	09-0.2247050	01-42401	01-42398	01-46794-04	01-42399	Obsolete	0.3431.484	0.2233.350	-
10-22362- Obsolete, repl. by 10-13027-	F9B-5	09-45581	09-802B	01-43137	01-46794-02	09-0.2247051	01-42424	01-42422-1	0.0144.003	01-42423	Obsolete	0.3431.486	0.2233.337/	0.3454.001 = 12V 2xA 0.3454.002 = 24V 2xA 0.3454.003 = 12V 1xB 0.3454.004 = 24V 1xB
10-24001-1 Obsolete	C1B-12V	-	Obsolete	-	-	0.2233.007	Obsolete	Obsolete	0.0256.011	-	-	-	Obsolete	-
10-24001-2 Obsolete	C1B-24V	-	Obsolete	-	-	0.2233.007	Obsolete	Obsolete	0.0256.011	-	-	-	Obsolete	-
10-24002-1 Obsolete, repl. by 10-24188-1	F5B-12V	-	Obsolete	01-42397	01-46794-05	Obsolete	01-42401	01-43252	01-46794-04	01-42399	-	-	-	Obsolete

A - parts no. 1, 4, 5, 7 included front * - gasket included ** - shaft drive end *** - included in service kit **** - back ***** -

Flexible Impeller Pumps

Part no.	Pump type	Service kit	Impeller	Cam	3	4	5	6	7	8	9	10	11	Clutch or Motor
A			1	2	3	4	5	6	7	8	9	10	11	
			Impeller	Cam	Camscrew	Seal	Gasket	Endcover	Endcover screw	Wearplate	Shaft	Bearing	Bearing seal	
10-24002-2 Obsolete, repl. by 10-24188-2	F5B-24V	-	Obsolete	01-42397	01-46794-05	Obsolete	01-42401	01-43252	01-46794-04	01-42399	-	-	-	Obsolete
10-24006-1 Customer branded	F9B-905	09-45582	09-814B	01-45172	01-46794-09	09-0.2247051	0.2173.459	01-45961	0.0138.134	01-42423	01-32253	0.3431.486	0.2233.002	-
10-24006-2 Customer branded	F9B-903	09-45582	09-814B	01-45384	01-46794-09	09-0.2247051	0.2173.459	01-45961	0.0138.134	01-42423	01-32253	0.3431.486	0.2233.002	-
10-24006-3 Obsolete	F9B-905	09-45582	09-814B	01-45172	01-46794-09	09-0.2247051	0.2173.459	01-45961	0.0138.134	01-42423	01-32253	0.3431.486	0.2233.002	-
10-24006-4 Obsolete	F9B-903	09-45582	09-814B	01-45384	01-46794-09	09-0.2247051	0.2173.459	01-45961	0.0138.134	01-42423	01-32253	0.3431.486	0.2233.002	-
10-24014-1	F7B-9000	-	09-1028B*	01-42679	01-46794-01	09-0.2247003	01-42445	01-42441	0.0279.033	01-42443	01-45006	0.3431.203	0.2233.004/ 0.2233.011	-
10-24014-2 Obsolete	F7B-9001	-	09-1028B*	01-42679	01-46794-01	09-0.2247003	01-42445	01-42441	0.0279.033	01-42443	01-45006	0.3431.203	0.2233.004/ 0.2233.011	-
10-24014-3 Obsolete	F7B-9002	-	09-1028B*	01-42679	01-46794-01	09-0.2247003	01-42445	01-42441	0.0279.033	01-42443	Obsolete	0.3431.203	0.2233.004/ 0.2233.011	-
10-24014-4	F7B-9030	-	09-1028B*	01-42442	01-46794-07	09-0.2247003	01-42445	01-42441	0.0279.033	01-42443	01-45006	0.3431.203	0.2233.004/ 0.2233.011	-
10-24014-5 Obsolete	F7B-9000	-	09-1028B*	01-42679	01-46794-01	09-0.2247003	01-42445	01-42441	0.0279.033	01-42443	01-45006	0.3431.203	0.2233.004/ 0.2233.011	-
10-24014-6 Obsolete	F7B-9030	-	09-1028B*	01-42442	01-46794-07	09-0.2247003	01-42445	01-42441	0.0279.033	01-42443	01-45006	0.3431.203	0.2233.004/ 0.2233.011	-
10-24014-7	F7B-9	-	09-1028B*	01-42679	01-46794-01	09-0.2247003	01-42445	01-42441	0.0279.033	01-42443	01-45006	0.3431.203	0.2233.406/ 0.2233.011	-
10-24015-1 Obsolete	F5B-9	09-45583	09-1027B-1*	01-42397	01-46794-05	09-0.2247050	01-42401	01-42398	01-46794-04	01-42399	01-31927-2	0.3431.484	0.2234.482	-
10-24017-1 Customer branded	F7B-903	09-45590	09-1028B*	01-42679	01-46794-07	09-0.2247050	01-42445	01-42441	01-46794-05	01-42443	01-31964	0.3431.486	0.2233.002	-
10-24017-2 Customer branded	F7B-903	09-45590	09-1028B*	01-42442	01-46794-07	09-0.2247050	01-42445	01-42441	01-46794-05	01-42443	01-31964	0.3431.486	0.2233.002	-
10-24017-3	F7B-903	09-45590	09-1028B*	01-42679	01-46794-07	09-0.2247050	01-42445	01-42441	01-46794-05	01-42443	01-31964	0.3431.486	0.2233.002	-
10-24017-4	F7B-903	09-45590	09-1028B*	01-42442	01-46794-07	09-0.2247050	01-42445	01-42441	01-46794-05	01-42443	01-31964	0.3431.486	0.2233.002	-
10-24018-1 Obsolete	F4B/F4B-4	-	09-1026B-1*	01-42389	01-46794-04	Obsolete	01-42391	-	Obsolete	-	Obsolete	0.3431.754	-	Obsolete

A - parts no. 1, 4, 5, 7 included front * - gasket included ** - shaft drive end *** - included in service kit **** - back ***** -

Flexible Impeller Pumps

Part no.	Pump type	Service kit	Impeller	Cam	Camscrew	Seal	Gasket	Endcover	7 Endcover screw	8 Wearplate	9 Shaft	10 Bearing	11 Bearing seal	Clutch or Motor
10-24018-2 Obsolete	F4B/F4B-4	-	09-1026B-1*	01-42389	01-46794-04	Obsolete	01-42391	-	Obsolete	-	Obsolete	0.3431.754	-	Obsolete
10-24020-1 Obsolete, repl. by 10-24017-1 (partly)	F7B-9	09-45590	09-1028B*	01-42679	01-46794-01	09-0.2247050	01-42445	01-42441	01-46794-05	01-42443	01-31964	0.3431.486	0.2233.002	-
10-24020-2 Obsolete, repl. by 10-24017-2 (partly)	F7B-9	09-45590	09-1028B*	01-42442	01-46794-01	09-0.2247050	01-42445	01-42441	01-46794-05	01-42443	01-31964	0.3431.486	0.2233.002	-
10-24026-1 Obsolete, repl. by 10-21915-1	F8B-903	09-45579	09-819B	01-42425	01-46794-02	09-0.2247051	01-42424	01-42422-1	0.0144.200	01-42423	01-32020	0.3431.486	0.2233.002	-
10-24027-1 Obsolete, repl. by 10-21915-1	F8B-903	09-45579	09-819B	01-42425	01-46794-02	09-0.2247051	01-42424	01-42422-1	0.0144.200	01-42423	01-32020	0.3431.486	0.2233.002	-
10-24028-1 Obsolete, repl. by 10-24017-2 (partly)	F7B-903	09-45590	09-1028B*	01-42442	01-46794-07	09-0.2247050	01-42445	01-42422-1	01-46794-05	01-42443	01-31964	0.3431.486	0.2233.002	-
10-24035-1 Obsolete, repl. by 10-24119-1	F5B-9001	09-45585	09-1027B-1*	01-42397	01-46794-05	0.2233.001	01-42401	01-42398	0.0279.500	01-42399	Obsolete	Obsolete	0.2233.001	-
10-24035-2 Obsolete, repl. by 10-24119-2	F5B-9002	09-45585	09-1027B-1*	01-42397	01-46794-05	0.2233.001	01-42401	01-42398	0.0279.500	01-42399	Obsolete	Obsolete	0.2233.001	-
10-24035-3 Obsolete, repl. by 10-24119-3	F5B-9022	09-45585	09-1027B-1*	01-45014	0.0279.032	0.2233.001	01-42401	01-42398	0.0279.500	01-42399	Obsolete	Obsolete	0.2233.001	-
10-24035-4 Obsolete, repl. by 10-24119-4	F5B-9003	09-45585	09-1027B-1*	01-42397	01-46794-05	0.2233.001	01-42401	01-42398	0.0279.500	01-42399	Obsolete	Obsolete	0.2233.001	-
10-24035-5 Obsolete, repl. by 10-24119-5	F5B-9004	09-45585	09-1027B-1*	01-42397	01-46794-05	0.2233.001	01-42401	01-42398	0.0279.500	01-42399	Obsolete	Obsolete	0.2233.001	-
10-24035-6 Obsolete, repl. by 10-24119-6	F5B-9005	09-45585	09-1027B-1*	01-42397	01-46794-05	0.2233.001	01-42401	01-42398	0.0279.500	01-42399	Obsolete	Obsolete	0.2233.001	-
10-24047-1 Obsolete	F5B/F4B-9	-	09-1027B-1* 09-1026B-1*	01-45014 01-42397	01-46794-04 0.0279.032	09-0.2247050	01-42401	-	Obsolete	01-42399	Obsolete	0.3431.482	0.2233.001	-
10-24048-1 Obsolete, repl. by 10-24017-4	F7B-903	09-45590	09-1028B*	01-42442	01-46794-07	09-0.2247050	01-42445	01-42441	01-46794-05	01-42443	01-31964	0.3431.486	0.2233.002	-
10-24053-1 Obsolete, repl. by 10-24131-1	F5B-902	09-45583	09-1027B-1*	01-45014	0.0279.032	09-0.2247050	01-42401	01-42398	01-46794-04	01-42399	Obsolete	0.3431.482	0.2233.001	-
10-24053-2 Obsolete, repl. by 10-24131-2	F5B-905	09-45583	09-1027B-1*	01-45199	0.0279.032	09-0.2247050	01-42401	01-42398	01-46794-04	01-42399	Obsolete	0.3431.482	0.2233.001	-
10-24057-1 Obsolete, repl. by 10-22335-2 (partly)	F7B-903	09-45590	09-1028B*	01-42442	01-46794-07	09-0.2247050	01-42445	01-42441	01-46794-05	01-42443	01-31964	0.3431.486	0.2233.002	-

A - parts no. 1, 4, 5, 7 included front * - gasket included ** - shaft drive end *** - included in service kit **** - back ***** -

Flexible Impeller Pumps

Part no.	Pump type	Service kit	Impeller	Cam	3	4	5	6	7	8	9	10	11	Clutch or Motor
A					Camscrew	Seal	Gasket	Endcover	Endcover screw	Wearplate	Shaft	Bearing	Bearing seal	
10-24061-1 Customer branded	F7B-9	09-45592	09-1028B*	01-42679	01-46794-07	0.2233.001	01-42445	01-42441	0.0141.502	-	01-45044	0.3431.483	0.2233.001 ***	-
10-24061-2 Customer branded	F7B-902	09-45592	09-1028B*	01-42584	01-46794-06	0.2233.001	01-42445	01-42441	0.0141.502	-	01-45044	0.3431.483	0.2233.001 ***	-
10-24061-3	F7B-9	09-45592	09-1028B*	01-42679	01-46794-07	0.2233.001	01-42445	01-42441	0.0141.502	-	01-45044	0.3431.483	0.2233.001 ***	-
10-24061-4 Obsolete	F7B-902	09-45592	09-1028B*	01-42584	01-46794-06	0.2233.001	01-42445	01-42441	0.0141.502	-	01-45044	0.3431.483	0.2233.001 ***	-
10-24070-1 Obsolete, repl by 10-24572-01	F7B-8	09-45592	09-1028B*	01-42679	01-46794-01	0.2233.001	01-42445	01-42441	0.0279.033	-	01-45045	0.3431.742	-	-
10-24070-2 Obsolete	F7B-89	09-45593	09-1028B-9	01-42679	01-46794-01	0.2233.001	01-42445	01-42441	0.0279.033	-	01-45045	0.3431.742	-	-
10-24070-3 Obsolete, repl by 10-24572-05	F7B-803	09-45592	09-1028B*	01-42442	01-46794-07	0.2233.001	01-42445	01-42441	0.0279.033	-	01-45045	0.3431.742	-	-
10-24070-4 Obsolete	F7B-893	09-45593	09-1028B-9	01-42442	01-46794-07	0.2233.001	01-42445	01-42441	0.0279.033	-	01-45045	0.3431.742	-	-
10-24070-5 Obsolete, repl. by 10-24572-51	F7B-8007	09-45592	09-1028B*	01-42679	01-46794-01	0.2233.001	01-42445	01-42441	0.0279.033	-	01-45045	0.3431.742	-	-
10-24070-6 Obsolete	F7B-8907	09-45593	09-1028B-9	01-42679	01-46794-01	0.2233.001	01-42445	01-42441	0.0279.033	-	01-45045	0.3431.742	-	-
10-24070-7 Obsolete	F7B-8037	09-45592	09-1028B*	01-42442	01-46794-07	0.2233.001	01-42445	01-42441	0.0279.033	-	01-45045	0.3431.742	-	-
10-24070-8 Obsolete	F7B-8937	09-45593	09-1028B-9	01-42442	01-46794-07	0.2233.001	01-42445	01-42441	0.0279.033	-	01-45045	0.3431.742	-	-
10-24070-9 Obsolete	F7B-8	09-45592	09-1028B*	01-42679	01-46794-01	0.2233.001	01-42445	01-46005	0.0279.033	-	01-45045	0.3431.742	-	-
10-24070-10 Obsolete	F7B-8	09-45592	09-1028B*	01-42679	01-46794-01	0.2233.252	01-42445	01-46431	0.0279.033	-	01-45045	0.3431.742	-	-
10-24070-51 Obsolete	F7B-8007	09-45592	09-1028B*	01-42679	01-46794-01	0.2233.001	01-42445	01-42441	0.0279.033	-	01-46417	0.3431.742	-	-

A - parts no. 1, 4, 5, 7 included front * - gasket included ** - shaft drive end *** - included in service kit **** - back ***** -

Flexible Impeller Pumps

Part no.	Pump type	Service kit	Impeller	Cam	3	4	5	6	7	8	9	10	11	Clutch or Motor
				Cam	Camscrew	Seal	Gasket	Endcover	Endcover screw	Wearplate	Shaft	Bearing	Bearing seal	
10-24071-98	F7B-50017	09-45592	09-1028B*	01-42679	01-46794-01	0.2233.001	01-42445	01-45961	0.0279.033	01-42423	01-45076			0.3454.001 = 12V 2xA 0.3454.002 = 24V 2xA 0.3454.003 = 12V 1xB 0.3454.004 = 24V 1xB
Obsolete, repl by 10-24577-98														
10-24071-99	F7B-5001	09-45592	09-1028B*	01-42679	01-46794-01	0.2233.001	01-42445	01-42441	0.0279.033	-	01-45076	0.3431.742	-	0.3454.001 = 12V 2xA 0.3454.002 = 24V 2xA 0.3454.003 = 12V 1xB 0.3454.004 = 24V 1xB
Obsolete, repl by 10-24577-99														
10-24072-1	F9B-9	09-45581	09-802B	01-45173	01-46794-09	09-0.2247051	0.2173.459	01-45961	0.0138.134	01-42423	01-32253	0.3431.486	0.2233.002	-
Customer branded														
10-24073-1	F5B-8	09-45585	09-1027B-1*	01-42397	01-46794-05	0.2233.001	01-42401	01-42398	0.0279.300	-	01-45045	0.3431.742	-	-
Obsolete, repl by 10-24571-01														
10-24073-2	F5B-802	09-45585	09-1027B-1*	01-45014	0.0279.032	0.2233.001	01-42401	01-42398	0.0279.300	-	01-45045	0.3431.742	-	-
Obsolete, repl by 10-24571-03														
10-24073-3	F5B-89	09-45586	09-1027B-9	01-42397	01-46794-05	0.2233.001	01-42401	01-42398	0.0279.300	-	01-45045	0.3431.742	-	-
Obsolete, repl by 10-24571-02														
10-24073-4	F5B-892	09-45586	09-1027B-9	01-45014	0.0279.032	0.2233.001	01-42401	01-42398	0.0279.300	-	01-45045	0.3431.742	-	-
Obsolete														
10-24073-5	F5B-8007	09-45585	09-1027B-1*	01-42397	01-46794-05	0.2233.001	01-42401	01-42398	0.0279.300	-	01-45045	0.3431.742	-	-
Obsolete, repl by 10-24571-51														
10-24073-6	F5B-8027	09-45585	09-1027B-1*	01-45014	0.0279.032	0.2233.001	01-42401	01-42398	0.0279.300	-	01-45045	0.3431.742	-	-
Obsolete														
10-24073-7	F5B-8907	09-45586	09-1027B-9	01-42397	01-42401	01-46794-05	0.2233.001	01-42398	0.0279.300	-	01-45045	0.3431.742	-	-
Obsolete														
10-24073-8	F5B-8927	09-45586	09-1027B-9	01-45014	0.0279.032	0.2233.001	01-42401	01-42398	0.0279.300	-	01-45045	0.3431.742	-	-
Not in production														
Obsolete														
10-24073-9	F5B-8	09-45585	09-1027B-1*	01-42397	01-46794-05	0.2233.001	01-42401	01-42398	0.0279.300	-	01-45045	0.3431.742	-	-
Obsolete														
10-24073-10	F5B-8	09-45585	09-1027B-1*	01-42397	01-46794-05	0.2233.001	01-42401	01-42398	0.0279.300	-	01-46039	0.3431.742	-	-
Obsolete														

A - parts no. 1, 4, 5, 7 included front * - gasket included ** - shaft drive end *** - included in service kit **** - back ***** -

Flexible Impeller Pumps

Part no.	Pump type	Service kit	Impeller	Cam	Cam screw	Seal	Gasket	Endcover	7 Endcover screw	8 Wearplate	9 Shaft	10 Bearing	11 Bearing seal	Clutch or Motor
10-24073-11 Obsolete	F5B-802	09-45585	09-1027B-1*	01-45014	0.0279.032	0.2233.001	01-45933	01-42398	0.0279.300	-	01-45045	0.3431.742	-	-
10-24073-12 Obsolete	F5B-8	09-45585	09-1027B-1*	01-42397	01-46794-05	0.2233.252	01-42401	01-46624	0.0279.300	-	01-45045	0.3431.742	-	-
10-24073-51 Obsolete	F5B-8007	09-45585	09-1027B-1*	01-42397	01-46794-05	0.2233.001	01-42401	01-42398	0.0279.300	-	01-46417	0.3431.742	-	-
10-24074-1 Obsolete, repl by 10-24570-01	F4B-8	09-45587	09-810B-1*	01-42389	01-46794-04	0.2233.010	01-42391	01-42398	0.0279.300	-	01-45069	0.3431.748	-	-
10-24074-2 Obsolete, repl by 10-24570-02	F4B-89	09-45588	09-810B-9	01-42389	01-46794-04	0.2233.010	01-42391	01-42398	0.0279.300	-	01-45069	0.3431.748	-	-
10-24074-3 Obsolete	F4B-802	09-45587	09-810B-1*	01-45084	0.0279.501	0.2233.010	01-42391	01-42398	0.0279.300	-	01-45069	0.3431.748	-	-
10-24074-4 Obsolete	F4B-892	09-45588	09-810B-9	01-45084	0.0279.501	0.2233.010	01-42391	01-42398	0.0279.300	-	01-45069	0.3431.748	-	-
10-24074-5 Not in production	F4B-803	09-45587	09-810B-1*	01-45288	01-46794-03	0.2233.010	01-42391	01-42398	0.0279.300	-	01-45069	0.3431.748	-	-
10-24074-6 Obsolete	F4B-893	09-45587	09-810B-9	01-45288	01-46794-03	0.2233.010	01-42391	01-42398	0.0279.300	-	01-45069	0.3431.748	-	-
10-24074-7 Obsolete, repl by 10-24570-07	F4B-8007	09-45587	09-810B-1*	01-42389	01-46794-04	0.2233.010	01-42391	01-42398	0.0279.300	-	01-45069	0.3431.748	-	-
10-24074-8 Obsolete	F4B-8907	09-45588	09-810B-9	01-42389	01-46794-04	0.2233.010	01-42391	01-42398	0.0279.300	-	01-45069	0.3431.748	-	-
10-24074-9 Obsolete	F4B-8027	09-45587	09-810B-1*	01-45084	0.0279.501	0.2233.010	01-42391	01-42398	0.0279.300	-	01-45069	0.3431.748	-	-
10-24074-10 Obsolete	F4B-8927	09-45588	09-810B-9	01-45084	0.0279.501	0.2233.010	01-42391	01-42398	0.0279.300	-	01-45069	0.3431.748	-	-
10-24074-11 Obsolete	F4B-8037	09-45587	09-810B-1*	01-45288	01-46794-03	0.2233.010	01-42391	01-42398	0.0279.300	-	01-45069	0.3431.748	-	-
10-24074-12 Obsolete	F4B-8937	09-45587	09-810B-9	01-45288	01-46794-03	0.2233.010	01-42391	01-42398	0.0279.300	-	01-45069	0.3431.748	-	-
10-24074-13 Obsolete	F4B-8	09-45587	09-810B-1*	01-42389	01-46794-04	0.2233.010	01-42391	01-46007	0.0279.300	-	01-45069	0.3431.748	-	-
10-24074-14 Obsolete	F4B-8	09-45587	09-810B-1*	01-42389	01-46794-04	0.2233.251	01-42391	01-46624	0.0279.300	-	01-45069	0.3431.748	-	-

A - parts no. 1, 4, 5, 7 included front * - gasket included ** - shaft drive end *** - included in service kit **** - back ***** -

Flexible Impeller Pumps

Part no.	Pump type	Service kit	Impeller	Cam	3	4	5	6	7	8	9	10	11	Clutch or Motor
					Camscrew	Seal	Gasket	Endcover	Endcover screw	Wearplate	Shaft	Bearing	Bearing seal	
10-24074-71 Obsolete, repl by 10-24570-51	F4B-8007	09-45587	09-810B-1*	01-42389	01-46794-04	0.2233,010	01-42391	01-42398	0.0279,300	-	01-46416	0.3431,748	-	-
10-24076-1 Obsolete, repl. by 10-24228-1	F5B-9	-	09-1027B-1*	01-45329	0.0279,033	Obsolete	01-45315	01-45312-1	01-46794-12	-	Obsolete	0.3431,754	-	-
10-24085-1 Obsolete	F5B-9	09-45583	09-1027B-1*	01-42397	01-46794-05	09-0.2247050	01-42401	01-42398	01-46794-04	01-42399	Obsolete	0.3431,778	0.2233,001	-
10-24086-1 Obsolete, repl. by 10-24184-1	F4B-9	09-45585	09-1027B-1*	01-42397	01-46794-05	0.2233,001	01-42401	01-42398	0.0279,500	01-42399	Obsolete	Obsolete	0.2233,001	-
10-24090-1	F9B-900	09-45581	09-802B	01-43137	01-46794-02	09-0.2247051	01-42424	01-42422-1	0.0144,003	01-42423	01-32020	0.3431,486	0.2233,002	-
10-24090-2 Not in production	F9B-903	09-45581	09-802B	01-43135	01-46794-02	09-0.2247051	01-42424	01-42422-1	0.0144,003	01-42423	01-32020	0.3431,486	0.2233,002	-
10-24091-1 Obsolete	F8B-900	09-45579	09-819B	01-42680	01-46794-02	09-0.2247051	01-42424	01-42422-1	0.0144,003	01-42423	01-32020	0.3431,486	0.2233,002	-
10-24091-2 Obsolete	F8B-903	09-45579	09-819B	01-42425	01-46794-02	09-0.2247051	01-42424	01-42422-1	0.0144,003	01-42423	01-32020	0.3431,486	0.2233,002	-
10-24091-3 Obsolete	F8B-902	09-45579	09-819B	01-42755	01-46794-08	09-0.2247051	01-42424	01-42422-1	0.0144,003	01-42423	01-32020	0.3431,486	0.2233,002	-
10-24095-1 Obsolete, repl. by 10-24074-1 + 10-24165-2	F4B/F4B-8	-	09-810B-1*	01-45288	01-46794-03	0.2233,010	01-42391	-	Obsolete	-	Obsolete	0.3431,748	-	-
10-24096-1 Obsolete	F8B-900	09-45579	09-819B	01-42680	01-46794-02	09-0.2247051	01-42424	01-42422-1	0.0144,200	01-42423	01-32020	0.3431,746	0.2233,002	-
10-24096-2 Obsolete	F8B-903	09-45579	09-819B	01-42425	01-46794-02	09-0.2247051	01-42424	01-42422-1	0.0144,200	01-42423	01-32020	0.3431,746	0.2233,002	-
10-24096-3 Obsolete	F8B-902	09-45579	09-819B	01-42755	01-46794-08	09-0.2247051	01-42424	01-42422-1	0.0144,200	01-42423	01-32020	0.3431,746	0.2233,002	-
10-24096-4	F8B-902	-	09-819B	01-42755	01-46794-08	09-0.2247051	01-42424	01-42422-1	0.0144,200	01-42423	01-32020	0.3431,746	0.2233,002	-
10-24097-1 Obsolete, repl. by 10-35098-2 + 10-24166-1	F4B/F4B-9	-	09-1026B-1*	01-42389	01-46794-04	0.2233,005	01-42391	-	-	-	Obsolete	-	-	-
10-24097-2 Obsolete, repl. by 10-35098-2 + 10-24166-1	F4B/F4B-9	-	09-1026B-1*	01-42389	01-46794-04	0.2233,005	01-42391	-	-	-	Obsolete	-	-	-
10-24099-1 Obsolete, repl. by 10-24074-1	F4B-8001	09-45587	09-810B-1*	01-42389	01-46794-04	0.2233,010	01-42391	01-42398	0.0279,501	-	Obsolete	0.3431,748	-	-

A - parts no. 1, 4, 5, 7 included front * - gasket included ** - shaft drive end *** - included in service kit **** - back ***** -

Flexible Impeller Pumps

Part no.	Pump type	Service kit	Impeller	Cam	3	4	5	6	7	8	9	10	11	Clutch or Motor
A				Cam	Camscrew	Seal	Gasket	Endcover	Endcover screw	Wearplate	Shaft	Bearing	Bearing seal	
10-24099-2 Obsolete, repl. by 10-24074-3	F4B-8021	09-45587	09-810B-1*	01-45084	0.0279.501	0.2233.010	01-42391	01-42398	0.0279.501	-	Obsolete	0.3431.748	-	-
10-24099-3 Obsolete, repl. by 10-24074-5	F4B-8031	09-45587	09-810B-1*	01-45288	01-46794-03	0.2233.010	01-42391	01-42398	0.0279.501	-	Obsolete	0.3431.748	-	-
10-24100-1	F5B-9	09-45585	09-1027B-1*	01-42397	01-46794-05	0.2233.001	01-42401	01-42398	0.0279.500	01-42399	01-45131	0.3431.204	0.2234.005	-
10-24103-1 Obsolete	F7B-9	09-45590	09-1028B*	01-42679	01-46794-01	09-0.2247.050	01-42445	01-42441	01-46794-05	01-42443	Obsolete	0.3431.484	0.2233.350	-
10-24103-2 Obsolete	F7B-903	09-45590	09-1028B*	01-42442	01-46794-07	09-0.2247.050	01-42445	01-42441	01-46794-05	01-42443	Obsolete	0.3431.484	0.2233.350	-
10-24112- Obsolete	F5B-5000	09-45583	09-1027B-1*	01-42397	01-46794-05	09-0.2247.050	01-42401	01-42398	01-46794-04	01-42399	01-35084	0.3431.778	0.2230.015	0.3454.001 = 12V 2xA 0.3454.002 = 24V 2xA 0.3454.003 = 12V 1xB 0.3454.004 = 24V 1xB
10-24113-1 Obsolete	F5B-8001	09-45585	09-1027B-1*	01-42397	01-46794-05	0.2233.001	01-42401	01-42398	0.0279.500	-	01-45045	0.3431.742	-	-
10-24114-1 Obsolete	F7B-8001	09-45592	09-1028B*	01-42679	01-46794-01	0.2233.001	01-42445	01-42441	0.0279.033	-	01-45045	0.3431.742	-	-
10-24116-98	F7B-5007	09-45590	09-1028B*	01-42679	01-46794-01	09-0.2247.050	01-42445	01-42441	01-46794-05	01-42443	01-35084	0.3431.778	0.2230.015	-
10-24116-99	F7B-5000	09-45590	09-1028B*	01-42679	01-46794-01	09-0.2247.050	01-42445	01-42441	01-46794-05	01-42443	01-35084	0.3431.778	0.2230.015	0.3454.001 = 12V 2xA 0.3454.002 = 24V 2xA 0.3454.003 = 12V 1xB 0.3454.004 = 24V 1xB
10-24119-1	F5B-9001	09-45585	09-1027B-1*	01-42397	01-46794-05	0.2233.001	01-42401	01-42398	0.0279.501	01-42399	01-45187	0.3431.761	-	-
10-24119-2	F5B-9002	09-45585	09-1027B-1*	01-42397	01-46794-05	0.2233.001	01-42401	01-42398	0.0279.501	01-42399	01-45187	0.3431.761	-	-
10-24119-3 Obsolete	F5B-9022	09-45585	09-1027B-1*	01-45014	0.0279.032	0.2233.001	01-42401	01-42398	0.0279.501	01-42399	01-45187	0.3431.761	-	-
10-24119-4	F5B-9003	09-45585	09-1027B-1*	01-42397	01-46794-05	0.2233.001	01-42401	01-42398	0.0279.501	01-42399	01-45187	0.3431.761	-	-
10-24119-5	F5B-9004	09-45585	09-1027B-1*	01-42397	01-46794-05	0.2233.001	01-42401	01-42398	0.0279.501	01-42399	01-45187	0.3431.761	-	-

A - parts no. 1, 4, 5, 7 included front * - gasket included ** - shaft drive end *** - included in service kit **** - back ***** -

Flexible Impeller Pumps

Part no.	Pump type	Service kit	Impeller	Cam	3	4	5	6	7	8	9	10	11	Clutch or Motor
A			1	2	Camscrew	Seal	Gasket	Endcover	Endcover screw	Wearplate	Shaft	Bearing	Bearing seal	
10-24119-6	F5B-9005	09-45585	09-1027B-1*	01-42397	01-46794-05	0.2233.001	01-42401	01-42398	0.0279.501	01-42399	01-45187	0.3431.761	-	-
10-24119-7	F5B-9006	09-45585	09-1027B-1*	01-42397	01-46794-05	0.2233.001	01-42401	01-42398	0.0279.501	01-42399	01-45187	0.3431.761	-	-
10-24119-8	F5B-9007	09-45585	09-1027B-1*	01-42397	01-46794-05	0.2233.001	01-42401	01-42398	0.0279.501	01-42399	01-45187	0.3431.761	-	-
Obsolete														
10-24123-1/-2	F3B-12V	09-45595	09-1052S-9*	Obsolete	0.0279.500	0.2233.007	01-43142	01-43141	0.0279.501	-	-	-	-	Obsolete
Obsolete, repl. by 10-24182-1/-2														
10-24124-1	F4B/F4B-9	09-45891	09-1026B-1*	01-42389	01-46794-04	0.2233.005	01-42391	01-42398	0.0279.501	-	Obsolete	Obsolete	-	-
Obsolete, repl. by 10-35098-2 + 10-24166-1						0.2233.010								
10-24124-2	F4B/F4B-9	09-45891	09-1026B-1*	01-42389	01-46794-04	0.2233.005	01-42391	01-42398	0.0279.501	-	Obsolete	Obsolete	-	-
Obsolete, repl. by 10-35098-2 + 10-24166-1						0.2233.010								
10-24124-3	F4B/F4B-9	09-45891	09-1026B-1*	01-42389	01-46794-04	0.2233.005	01-45401	01-42398	0.0279.501	-	Obsolete	Obsolete	-	-
Obsolete, repl. by 10-35098-2 + 10-24166-1						0.2233.010								
10-24124-4	F4B/F4B-9	09-45891	09-1026B-1*	01-42389	01-46794-04	0.2233.005	01-45401	01-42398	0.0279.501	-	Obsolete	Obsolete	-	-
Obsolete, repl. by 10-35098-2 + 10-24166-1						0.2233.010								
10-24124-5	F4B/F4B-9	09-45891	09-1026B-1*	01-42389	01-46794-04	0.2233.005	01-42391	01-42398	0.0279.501	-	Obsolete	Obsolete	-	-
Obsolete, repl. by 10-35098-2 + 10-24166-1						0.2233.010								
10-24124-6	F4B/F4B-9	09-45891	09-1026B-1*	01-42389	01-46794-04	0.2233.005	01-42391	01-42398	0.0279.501	-	Obsolete	Obsolete	-	-
Obsolete, repl. by 10-35098-2 + 10-24166-1						0.2233.010								
10-24126-1	F7B-903	09-45592	09-1028B*	01-42442	01-46794-07	0.2233.001	01-42445	01-42441	0.0279.033	-	01-45044	0.3431.483	0.2233.001	-
Obsolete													***	
10-24126-2	F7B-9	09-45592	09-1028B*	01-42679	01-46794-01	0.2233.001	01-42445	01-42441	0.0279.033	-	01-45044	0.3431.742	0.2233.001	-
Obsolete													***	
10-24126-3	F7B-903	09-45592	09-1028B*	01-42442	01-46794-07	0.2233.001	01-42445	01-42441	0.0279.033	-	01-46469	0.3431.742	-	-
Obsolete														
10-24127-1	F7B-9	09-45592	09-1028B*	01-42679	01-46794-01	0.2233.001	01-42445	01-42441	0.0279.033	-	01-45248	0.3431.483	0.2233.001	-

10-24127-2	F7B-903	09-45592	09-1028B*	01-42442	01-46794-07	0.2233.001	01-42445	01-42441	0.0279.033	-	01-45248	0.3431.483	0.2233.001	-
Not in production													***	
10-24127-3	F7B-902	09-45592	09-1028B*	01-42584	01-46794-06	0.2233.001	01-42445	01-42441	0.0279.033	-	01-45248	0.3431.483	0.2233.001	-
Not in production													***	
10-24130-2	F8B-905	-	09-1029B	01-45317	01-46794-02	0.2233.250	01-45354	01-42422-1	0.0138.134	01-42423	01-45316	0.3431.780	-	-
Customer branded														
10-24130-3	F8B-905	09-45705	09-819B	01-45317	01-46794-02	0.2233.250	01-45354	01-42422-1	0.0138.134	01-42423	01-45316	0.3431.780	-	-
10-24131-1	F5B-902	09-45585	09-1027B-1*	01-45014	0.0279.032	0.2233.001	01-42401	01-42398	0.0279.500	01-42399	01-45320	0.3431.483	0.2233.001	-

A - parts no. 1, 4, 5, 7 included front * - gasket included ** - shaft drive end *** - included in service kit **** - back ***** -

Flexible Impeller Pumps

Part no.	Pump type	Service kit	Impeller	Cam	3	4	5	6	7	8	9	10	11	Clutch or Motor
					Camscrew	Seal	Gasket	Endcover	Endcover screw	Wearplate	Shaft	Bearing	Bearing seal	
10-24131-2	F5B-905	09-45585	09-1027B-1*	01-45199	0.0279.032	0.2233.001	01-42401	01-42398	0.0279.500	01-42399	01-45320	0.3431.483	0.2233.001	-
10-24131-3	F5B-902	09-45585	09-1027B-1*	01-45014	0.0279.032	0.2233.001	01-42401	01-42398	0.0279.500	01-42399	01-45320	0.3431.483	0.2233.001	-
Not in production														
10-24131-4	F5B-905	09-45585	09-1027B-1*	01-45199	0.0279.032	0.2233.001	01-42401	01-42398	0.0279.500	01-42399	01-45320	0.3431.483	0.2233.001	-
Customer branded														
10-24135-1/-2	T50-12V	-	Obsolete	-	-	Obsolete	-	Obsolete	-	-	-	-	-	Obsolete
Obsolete, repl. by 10-24240-1/-2														
10-24139-1	F7B-9	09-45590	09-1028B*	01-42679	01-46794-01	09-0.2247.050	01-42445	01-42441	01-46794-05	01-42443	01-45324	0.3431.484	0.2233.350	-
10-24139-2	F7B-903	09-45590	09-1028B*	01-42442	01-46794-07	09-0.2247.050	01-42445	01-42441	01-46794-05	01-42443	01-45324	0.3431.484	0.2233.350	-
10-24139-3	F7B-9	09-45590	09-1028B*	01-42679	01-46794-01	09-0.2247.050	01-42445	01-42441	01-46794-05	01-42443	01-45324	0.3431.484	0.2233.350	-
10-24139-4	F7B-903	09-45590	09-1028B*	01-42442	01-46794-07	09-0.2247.050	01-42445	01-42441	01-46794-05	01-42443	01-45324	0.3431.484	0.2233.350	-
10-24139-5	F7B-9	09-45590	09-1028B*	01-42679	01-46794-01	09-0.2247.050	01-42445	01-42441	01-46794-05	01-42443	01-45324	0.3431.484	0.2233.350	-
10-24139-7	F7B-9	09-45590	09-1028B*	01-42679	01-46794-01	09-0.2247.050	01-42445	01-42441	01-46794-05	01-42443	01-45324	0.3431.484	0.2233.350	-
10-24140-1	F5B-9	09-45583	09-1027B-1*	01-42397	01-46794-05	09-0.2247.050	01-42401	01-42398	01-46794-04	01-42399	01-45324	0.3431.484	0.2233.350	-
10-24140-2	F5B-902	09-45583	09-1027B-1*	01-45014	0.0279.032	09-0.2247.050	01-42401	01-42398	01-46794-04	01-42399	01-45324	0.3431.484	0.2233.350	-
Not in production														
10-24140-3	F5B-9	09-45583	09-1027B-1*	01-42397	01-46794-05	09-0.2247.050	01-42401	01-42398	01-46794-04	01-42399	01-45324	0.3431.484	0.2233.350	-
10-24140-4	F5B-902	09-45583	09-1027B-1*	01-45014	0.0279.032	09-0.2247.050	01-42401	01-42398	01-46794-04	01-42399	01-45324	0.3431.484	0.2233.350	-
Not in production														
10-24140-5	F5B-9	09-45583	09-1027B-1*	01-42397	01-46794-05	09-0.2247.050	01-42401	01-42398	01-46794-04	01-42399	01-45324	0.3431.484	0.2233.350	-
10-24143-1	F35B-902	09-45900	09-808B-1*	01-42415	01-46794-10	0.2233.200	01-43240	01-45359	0.0141.500	01-45087	01-45360	01-45110	-	-
10-24143-2	F35B-902	09-45900	09-808B-1*	01-42415	01-46794-10	0.2233.200	01-45400	01-45359	0.0141.500	01-45087	01-45360	01-45110	-	-
10-24143-3	F35B-9	09-45900	09-808B-1*	01-42910	01-46794-03	0.2233.200	01-43240	01-45359	0.0141.500	01-45087	01-45360	01-45110	-	-
10-24143-4	F35B-9	09-45900	09-808B*	01-42910	01-46794-03	0.2233.200	01-45400	01-45359	0.0141.500	01-45087	01-45360	01-45110	-	-
Not in production			09-808B-1*											
10-24143-5	F35B-9	09-45900	09-808B-1*	01-42910	01-46794-03	0.2233.200	01-43240	01-45359	0.0141.500	01-45087	01-45360	01-45110	-	-
10-24144-1	F4B-9	09-45587	09-810B-1*	01-42389	01-46794-04	0.2233.010	01-42391	01-42388-2	0.0141.500	-	01-45313	01-45207-3	-	-

A - parts no. 1, 4, 5, 7 included front * - gasket included ** - shaft drive end *** - included in service kit **** - back

Flexible Impeller Pumps

Part no.	Pump type	Service kit	Impeller	Cam	3	4	5	6	7	8	9	10	11	Clutch or Motor
					Camscrew	Seal	Gasket	Endcover	Endcover screw	Wearplate	Shaft	Bearing	Bearing seal	
10-24144-2	F4B-9	09-45587	09-810B-1*	01-42389	01-46794-04	0.2233.010	01-45401	01-42388-2	0.0141.500	-	01-45313	01-45207-3	-	-
10-24159-1 Obsolete	F9B-9	09-45920	09-814B	01-45173	01-46794-09	09-0.2247.008	01-42424	01-42422-1	0.0138.134	01-42423	01-35140	0.3431.684	0.2234.006	-
10-24159-2 Obsolete	F9B-905	09-45920	09-814B	01-45172	01-46794-09	09-0.2247.008	01-42424	01-42422-1	0.0138.134	01-42423	01-35140	0.3431.684	0.2234.006	-
10-24160-1 Customer branded	F8B-5	-	09-1029B	01-42680	01-46794-02	09-0.2247.051	01-42424	01-42422-1	0.0144.200	01-42423	01-35138	0.3431.780	0.2230.319	-
10-24160-2 Customer branded	F8B-5	-	09-1029B	01-42680	01-46794-02	09-0.2247.051	01-42424	01-42422-1	0.0144.200	01-42423	01-35138	0.3431.780	0.2230.319	-
10-24161-1 Customer branded	F9B-5	-	09-814B	01-43137	01-46794-02	09-0.2247.051	01-42424	01-42422-1	0.0144.200	01-42423	01-35138	0.3431.780	0.2230.319	-
10-24164-1 Obsolete	F4B-8	09-45587	09-810B-1*	01-42389	01-46794-04	0.2233.010	01-42391	01-42388-2	0.0141.500	-	01-45313	01-45207-3	-	-
10-24164-2 Obsolete	F4B-8	09-45587	09-810B-1*	01-42389	01-46794-04	0.2233.010	01-45401	01-42388-2	0.0141.500	-	01-45313	01-45207-3	-	-
10-24165-1 Obsolete	F4B-9	-	09-810B-1*	01-42389	01-46794-04	-	01-42391	01-42388-2	0.0141.500	-	01-45313	01-45207-3	-	-
10-24165-2	F4B-903	-	09-810B-1*	01-45288	01-46794-03	-	01-42391	01-42388-2	0.0141.500	-	01-45313	01-45207-3	-	-
10-24166-1	F4B-9	-	09-810B-1*	01-42389	01-46794-04	-	01-42391	01-42388-2	0.0141.500	-	01-45313	01-45207-3	-	-
10-24166-2	F4B-903	-	09-810B-1*	01-45288	01-46794-03	-	01-42391	01-42388-2	0.0141.500	-	01-45313	01-45207-3	-	-
10-24167-1 Obsolete, repl. By 10-35098-2 + 10-24166-1	F4B/F4B-9	-	09-1026B-1*	01-42389	01-46794-04	0.2233.005	01-42391	01-42398	0.0279.501	-	Obsolete	Obsolete	-	-
10-24167-2 Obsolete, repl. By 10-35098-2 + 10-24166-1	F4B/F4B-9	-	09-1026B-1*	01-42389	01-46794-04	0.2233.005	01-42391	01-42398	0.0279.501	-	Obsolete	Obsolete	-	-
10-24174-1 Obsolete, repl. by 10-24225-1	F5B-9	Obsolete	09-1027B-1*	01-45329	0.0279.033	Obsolete	01-45315	01-45312-1	0.0141.502	-	Obsolete	0.3431.754	-	-
10-24178-1 Customer branded	F35B-902	09-45589	09-808B-1*	01-42415	01-46794-10	0.2233.010	01-43240	01-43239	0.0279.501	01-45087	01-45543	0.3431.441	0.2233.010 ***	-
10-24178-2 Obsolete, repl. by 10-24707-01	F35B-902	09-45589	09-808B-1*	01-42415	01-46794-10	0.2233.010	01-43240	01-43239	0.0279.501	01-45087	01-45543	0.3431.441	0.2233.010 ***	-

A - parts no. 1, 4, 5, 7 included front * - gasket included ** - shaft drive end *** - included in service kit **** - back ***** -

Flexible Impeller Pumps

Part no.	Pump type	Service kit	Impeller	Cam	3	4	5	6	7	8	9	10	11	Clutch or Motor
A					Camscrew	Seal	Gasket	Endcover	Endcover screw	Wearplate	Shaft	Bearing	Bearing seal	
10-24178-3 Customer branded	F3B-9	09-45589	09-808B-1*	01-42910	01-46794-03	0.2233.010	01-43240	01-43239	0.0279.501	01-45087	01-45543	0.3431.441	0.2233.010 ***	-
10-24179-1	F7B-9	09-45592	09-1028B*	01-42679	01-46794-01	0.2233.001	01-42445	01-42441	0.0141.502	-	01-45573	0.3431.483	0.2233.001 ***	-
10-24179-2	F7B-903	09-45592	09-1028B*	01-42442	01-46794-07	0.2233.001	01-42445	01-42441	0.0141.502	-	01-45573	0.3431.483	0.2233.001 ***	-
10-24180-1	F2P10-19 12V	09-45594	09-1077B-9*	-	-	0.2233.402	0.2172.506	21-4945	0.0140.001	21-4944**** 21-4946*****	-	-	-	01-35285-01
10-24180-2	F2P10-19 24V	09-45594	09-1077B-9*	-	-	0.2233.402	0.2172.506	21-4945	0.0140.001	21-4944**** 21-4946*****	-	-	-	01-35285-02
10-24180-3	F2P10-19 12V USA	09-45594	09-1077B-9*	-	-	0.2233.402	0.2172.506	21-4945	0.0140.001	21-4944**** 21-4946*****	-	-	-	01-35285-01
10-24180-4	F2P10-19 24V USA	09-45594	09-1077B-9*	-	-	0.2233.402	0.2172.506	21-4945	0.0140.001	21-4944**** 21-4946*****	-	-	-	01-35285-02
10-24181-1	F8B-9	09-45705	09-819B	01-42680	01-46794-02	0.2233.250	01-45354	01-42422-1	0.0138.134	01-42423	01-45547	0.3431.780	-	-
10-24181-2	F8B-903	09-45705	09-819B	01-42425	01-46794-02	0.2233.250	01-45354	01-42422-1	0.0138.134	01-42423	01-45547	0.3431.780	-	-
10-24181-3 Not in production	F8B-9	-	09-819B	01-42680	01-46794-02	0.2234.337	01-45354	01-42422-1	0.0138.134	01-42423	01-45547	0.3431.780	-	-
10-24181-4 Not in production	F8B-903	-	09-819B	01-42425	01-46794-02	0.2234.337	01-45354	01-42422-1	0.0138.134	01-42423	01-45547	0.3431.780	-	-
10-24182-1 Obsolete, repl. by 10-24516-01	F3B-19 12V	09-45595	09-1052S-9*	01-45548	0.0279.500	0.2233.007	01-43142	01-43141	0.0279.501	-	-	-	-	01-35285-01
10-24182-2 Obsolete, repl. by 10-24516-02	F3B-19 24V	09-45595	09-1052S-9*	01-45548	0.0279.500	0.2233.007	01-43142	01-43141	0.0279.501	-	-	-	-	01-35285-02
10-24182-3 Obsolete, repl. by 10-24516-03	F3B-1907 12V	09-45595	09-1052S-9*	01-45548	0.0279.500	0.2233.007	01-43142	01-43141	0.0279.501	-	-	-	-	01-35285-01
10-24182-4 Obsolete, repl. by 10-24516-04	F3B-1907 24V	09-45595	09-1052S-9*	01-45548	0.0279.500	0.2233.007	01-43142	01-43141	0.0279.501	-	-	-	-	01-35285-02
10-24182-7 Obsolete, repl. by 10-24516-05	F3B-19 12V	09-45595	09-1052S-9*	01-45548	0.0279.500	0.2233.007	01-43142	01-46008	0.0279.501	-	-	-	-	01-35285-01
10-24182-8 Obsolete, repl. by 10-24516-06	F3B-19 24V	09-45595	09-1052S-9*	01-45548	0.0279.500	0.2233.007	01-43142	01-46008	0.0279.501	-	-	-	-	01-35285-02

A - parts no. 1, 4, 5, 7 included front * - gasket included ** - shaft drive end *** - included in service kit **** - back ***** -

Flexible Impeller Pumps

Part no.	Pump type	Service kit	Impeller	Cam	Cam screw	Seal	Gasket	Endcover	Endcover screw	Wearplate	Shaft	Bearing	Bearing seal	Clutch or Motor
A	1	2	3	4	5	6	7	8	9	10	11			
10-24183-1	F7B-9000	09-45592	09-1028B*	01-42679	01-46794-01	09-0.2247050	01-42445	01-42441	0.0279.033	01-42443	01-45555	0.3431.203	0.2233.004/ 0.2233.011	-
10-24184-1	F5B-9	09-45585	09-1027B-1*	01-42397	01-46794-05	0.2233.001	01-42401	01-42398	0.0279.500	01-42399	01-45553	0.3431.761	-	-
10-24188-1	F5B-19 12V	09-45584	09-1027B-9	01-42397	01-46794-05	09-0.2247050	01-42401	01-43252	01-46794-04	01-42399	-	-	-	01-24391-1
10-24188-2	F5B-19 24V	09-45584	09-1027B-9	01-42397	01-46794-05	09-0.2247050	01-42401	01-43252	01-46794-04	01-42399	-	-	-	01-24391-2
10-24188-4	F5B-1907 12V	09-45584	09-1027B-9	01-42397	01-46794-05	09-0.2247050	01-42401	01-46007	01-46794-04	01-42399	-	-	-	01-24391-1
10-24188-5	F5B-1907 24V	09-45584	09-1027B-9	01-42397	01-46794-05	09-0.2247050	01-42401	01-46007	01-46794-04	01-42399	-	-	-	01-24391-2
10-24188-7 Not in production	F5B-19 12V	09-45584	09-1027B-9	01-42397	01-46794-05	09-0.2247050	01-42401	01-46007	01-46794-04	01-42399	-	-	-	01-24391-1
10-24188-8 Not in production	F5B-19 24V	09-45584	09-1027B-9	01-42397	01-46794-05	09-0.2247050	01-42401	01-46007	01-46794-04	01-42399	-	-	-	01-24391-2
10-24188-10 Not in production	F5B-19 24V	09-45584	09-1027B-9	01-42397	01-46794-05	09-0.2247050	01-46395	01-46007	01-46794-04	01-42399	-	-	-	01-24391-5
10-24205-1	F4B-85	-	09-810B-5	01-42389	01-46794-04	0.2233.010	01-42391	01-42398	0.0279.501	-	01-45069	0.3431.748	-	-
10-24209-1	F7B-3000	09-45590	09-1028B*	01-42679	01-46794-01	09-0.2247050	01-42445	01-42441	01-46794-05	01-42443	01-35177	0.3431.778	0.2234.004/ 0.2230.015	-
10-24209-2	F7B-3900	09-45591	09-1028B-9	01-42679	01-46794-01	09-0.2247050	01-42445	01-42441	01-46794-05	01-42443	01-35177	0.3431.778	0.2234.004/ 0.2230.015	-
10-24209-3 Not in production	F7B-3030	09-45590	09-1028B*	01-42442	01-46794-07	09-0.2247050	01-42445	01-42441	01-46794-05	01-42443	01-35177	0.3431.778	0.2234.004/ 0.2230.015	-
10-24209-4 Not in production	F7B-3930	09-45591	09-1028B-9	01-42442	01-46794-07	09-0.2247050	01-42445	01-42441	01-46794-05	01-42443	01-35177	0.3431.778	0.2234.004/ 0.2230.015	-
10-24209-5 Not in production	F7B-3020	09-45590	09-1028B*	01-42584	01-46794-06	09-0.2247050	01-42445	01-42441	01-46794-05	01-42443	01-35177	0.3431.778	0.2234.004/ 0.2230.015	-
10-24209-6 Not in production	F7B-3920	09-45590	09-1028B-9	01-42584	01-46794-06	09-0.2247050	01-42445	01-42441	01-46794-05	01-42443	01-35177	0.3431.778	0.2234.004/ 0.2230.015	-
10-24209-7	F7B-30007	09-45590	09-1028B*	01-42679	01-46794-01	09-0.2247050	01-42445	01-42441	01-46794-05	01-42443	01-35177	0.3431.778	0.2234.004/ 0.2230.015	-
10-24209-8 Not in production	F7B-39007	09-45590	09-1028B-9	01-42679	01-46794-01	09-0.2247050	01-42445	01-42441	01-46794-05	01-42443	01-35177	0.3431.778	0.2234.004/ 0.2230.015	-
10-24209-9 Not in production	F7B-30307	09-45590	09-1028B*	01-42442	01-46794-07	09-0.2247050	01-42445	01-42441	01-46794-05	01-42443	01-35177	0.3431.778	0.2234.004/ 0.2230.015	-

A - parts no. 1, 4, 5, 7 included front * - gasket included ** - shaft drive end *** - included in service kit **** - back ***** -

Flexible Impeller Pumps

Part no.	Pump type	Service kit	Impeller	Cam	3	4	5	6	7	8	9	10	11	Clutch or Motor
					Camscrew	Seal	Gasket	Endcover	Endcover screw	Wearplate	Shaft	Bearing	Bearing seal	
10-24209-10 Not in production	F7B-39307	09-45591	09-1028B-9	01-42442	01-46794-07	09-0.2247050	01-42445	01-42441	01-46794-05	01-42443	01-35177	0.3431.778	0.2234.004/ 0.2230.015	-
10-24209-11 Not in production	F7B-30207	09-45590	09-1028B*	01-42584	01-46794-06	09-0.2247050	01-42445	01-42441	01-46794-05	01-42443	01-35177	0.3431.778	0.2234.004/ 0.2230.015	-
10-24209-12 Not in production	F7B-39207	09-45590	09-1028B-9	01-42584	01-46794-06	09-0.2247050	01-42445	01-42441	01-46794-05	01-42443	01-35177	0.3431.778	0.2234.004/ 0.2230.015	-
10-24210-1	F5B-3000	09-45583	09-1027B-1*	01-42397	01-46794-05	09-0.2247050	01-42401	01-42398	01-46794-04	01-42399	01-35177	0.3431.778	0.2234.004/ 0.2230.015	-
10-24210-2 Not in production	F5B-3900	09-45584	09-1027B-9	01-42397	01-46794-05	09-0.2247050	01-42401	01-42398	01-46794-04	01-42399	01-35177	0.3431.778	0.2234.004/ 0.2230.015	-
10-24210-3 Not in production	F5B-3020	09-45583	09-1027B-1*	01-45014	0.0279.032	09-0.2247050	01-42401	01-42398	01-46794-04	01-42399	01-35177	0.3431.778	0.2234.004/ 0.2230.015	-
10-24210-4 Not in production	F5B-3920	09-45584	09-1027B-9	01-45014	0.0279.032	09-0.2247050	01-42401	01-42398	01-46794-04	01-42399	01-35177	0.3431.778	0.2234.004/ 0.2230.015	-
10-24210-5	F5B-30007	09-45583	09-1027B-1*	01-42397	01-46794-05	09-0.2247050	01-42401	01-42398	01-46794-04	01-42399	01-35177	0.3431.778	0.2234.004/ 0.2230.015	-
10-24210-6 Not in production	F5B-39007	09-45584	09-1027B-9	01-42397	01-46794-05	09-0.2247050	01-42401	01-42398	01-46794-04	01-42399	01-35177	0.3431.778	0.2234.004/ 0.2230.015	-
10-24210-7 Not in production	F5B-30207	09-45583	09-1027B-1*	01-45014	0.0279.032	09-0.2247050	01-42401	01-42398	01-46794-04	01-42399	01-35177	0.3431.778	0.2234.004/ 0.2230.015	-
10-24210-8 Not in production	F5B-39207	09-45584	09-1027B-9	01-45014	0.0279.032	09-0.2247050	01-42401	01-42398	01-46794-04	01-42399	01-35177	0.3431.778	0.2234.004/ 0.2230.015	-
10-24214-1	F4B-9	09-45872	09-810B-1*	01-45660	0.0279.501	0.2233.251	01-45284	01-45282	0.0279.501	-	01-45658	0.3431.748	-	-
10-24214-2 Not in production	F4B-903	09-45872	09-810B-1*	Obsolete	0.0279.501	0.2233.251	01-45284	01-45282	0.0279.501	-	01-45658	0.3431.748	-	-
10-24214-3 Not in production	F4B-902	09-45872	09-810B-1*	01-45084	0.0279.501	0.2233.251	01-45284	01-45282	0.0279.501	-	01-45658	0.3431.748	-	-
10-24214-4	F4B-9	09-45872	09-810B-1*	01-45660	0.0279.501	0.2233.251	01-45284	01-45282	0.0279.501	-	01-45658	0.3431.748	-	-
10-24214-5 Not in production	F4B-903	09-45872	09-810B-1*	Obsolete	0.0279.501	0.2233.251	01-45284	01-45282	0.0279.501	-	01-45658	0.3431.748	-	-
10-24214-6 Not in production	F4B-902	09-45872	09-810B-1*	01-45084	0.0279.501	0.2233.251	01-45284	01-45282	0.0279.501	-	01-45658	0.3431.748	-	-

A - parts no. 1, 4, 5, 7 included front * - gasket included ** - shaft drive end *** - included in service kit **** - back ***** -

Flexible Impeller Pumps

Part no.	Pump type	Service kit	Impeller	Cam	3	4	5	6	7	8	9	10	11
				Cam	Camscrew	Seal	Gasket	Endcover	Endcover screw	Wearplate	Shaft	Bearing	Bearing seal
			1	2	3	4	5	6	7	8	9	10	11
			Impeller	Cam	Camscrew	Seal	Gasket	Endcover	Endcover screw	Wearplate	Shaft	Bearing	Bearing seal
10-24215-1 Obsolete	F5B-9	09-45585	09-1027B-1*	01-42397	01-46794-05	0.2233.001	01-42401	01-42398	0.0279.500	01-42399	Obsolete	0.3431.761	-
10-24218-1	F7B-903	09-45592	09-1028B*	01-42442	01-46794-07	0.2233.001	01-42445	01-42441	0.0279.033	-	01-45044	0.3431.483	0.2233.001 ***
10-24225-1	F5B-9	09-45808	09-1027B-1*	01-45329	0.0279.033	0.2233.252	01-45315	01-45312-1	0.0141.502	-	01-45681	0.3431.742	-
10-24225-2	F5B-902	09-45808	09-1027B-1*	01-45656	0.0279.032	0.2233.252	01-45315	01-45312-1	0.0141.502	-	01-45681	0.3431.742	-
10-24225-3 Customer branded	F5B-9	09-45808	09-1027B-1*	01-45329	0.0279.033	0.2233.252	01-45315	01-45312-1	0.0141.502	-	01-45681	0.3431.742	-
10-24226-1	F5B-85	-	09-1027B-5	01-42397	01-46794-05	0.2233.001	01-42401	01-42398	0.0279.500	-	01-45045	0.3431.742	-
10-24228-1	F5B-9	09-45808	09-1027B-1*	01-45329	0.0279.033	0.2233.001	01-45315	01-45312-1	0.0141.502	-	01-45681	0.3431.742	-
10-24228-2 Not in production	F5B-902	09-45808	09-1027B-1*	01-45656	0.0279.032	0.2233.001	01-45315	01-45312-1	0.0141.502	-	01-45681	0.3431.742	-
10-24228-3 Not in production	F5B-9	09-45808	09-1027B-1*	01-45329	0.0279.033	0.2233.001	01-45315	01-45312-1	0.0141.502	-	01-45681	0.3431.742	-
10-24228-4 Not in production	F5B-902	09-45808	09-1027B-1*	01-45656	0.0279.032	0.2233.001	01-45315	01-45312-1	0.0141.502	-	01-45681	0.3431.742	-
10-24228-5 Not in production	F5B-9	09-45808	09-1027B-1*	01-45329	0.0279.033	0.2233.001	01-45315	01-45312-1	0.0141.502	-	01-45681	0.3431.742	-
10-24228-6 Not in production	F5B-9	09-45808	09-1027B-1*	01-45329	0.0279.033	0.2233.252	01-45315	01-45312-1	0.0141.502	-	01-45681	0.3431.742	-
10-24230-1 Not in production	F5B-9	09-45808	09-1027B-1*	01-45329	0.0279.033	0.2233.252	01-45315	01-45312-1	0.0141.502	-	01-45681	0.3431.742	-
10-24230-2	F5B-902	09-45808	09-1027B-1*	01-45656	0.0279.032	0.2233.252	01-45315	01-45312-1	0.0141.502	-	01-45681	0.3431.742	-
10-24230-3	F5B-9	09-45808	09-1027B-1*	01-45329	0.0279.033	0.2233.252	01-45315	01-45312-1	0.0141.502	-	01-45681	0.3431.742	-
10-24230-4 Not in production	F5B-902	09-45808	09-1027B-1*	01-45656	0.0279.032	0.2233.252	01-45315	01-45312-1	0.0141.502	-	01-45681	0.3431.742	-
10-24230-5	F5B-9	-	09-1027B-1*	01-45329	0.0279.033	0.2233.001	01-45315	01-45312-1	0.0141.502	-	01-45681	0.3431.742	-
10-24232-1	F6B-9	09-45825	09-812B-1**	01-45670	0.0279.033	0.2233.001	01-45315	01-45312-1	0.0141.502	-	01-45681	0.3431.742	-
10-24232-2 Not in production	F6B-902	09-45825	09-812B-1**	Obsolete	0.0279.032	0.2233.001	01-45315	01-45312-1	0.0141.502	-	01-45681	0.3431.742	-
10-24232-3 Not in production	F6B-9	09-45825	09-812B-1**	01-45670	0.0279.033	0.2233.001	01-45315	01-45312-1	0.0141.502	-	01-45681	0.3431.742	-

A - parts no. 1, 4, 5, 7 included front * - gasket included ** - shaft drive end *** - included in service kit **** - back ***** -

Flexible Impeller Pumps

Part no.	Pump type	Service kit	Impeller	Cam	Cam screw	Seal	Gasket	Endcover	Endcover screw	Wearplate	Shaft	Bearing	Bearing seal	Clutch or Motor
A	1	2	3	4	5	6	7	8	9	10	11			
10-24232-4 Not in production	F6B-902	09-45825	09-812B-1**	01-45687	0.0279.032	0.2233.001	01-45315	01-45312-1	0.0141.502	-	01-45681	0.3431.742	-	-
10-24232-5 Customer branded	F6B-9	09-45825	09-812B-1**	01-45670	0.0279.033	0.2233.001	01-45315	01-45312-1	0.0141.502	-	01-45681	0.3431.742	-	-
10-24232-6 Customer branded	F6B-9	09-45825	09-812B-1**	01-45670	0.0279.033	0.2233.252	01-45315	01-45312-1	0.0141.502	-	01-45681	0.3431.742	-	-
10-24232-7 Customer branded	F6B-9	09-45825	09-812B-1*-1*	01-45670	0.0279.033	0.2233.001	01-45315	01-45312-1	0.0141.502	-	01-45681	0.3431.742	-	-
10-24232-8B Customer branded	F6B-9	09-45825	09-812B-1*-1*	01-45670	0.0279.033	0.2233.001	01-45315	01-45312-1	0.0141.502	-	01-45681	0.3431.742	-	-
10-24234-1 Obsolete	F6B-9	09-45825	09-812B-1**	01-45670	0.0279.033	0.2233.252	01-45315	01-45312-1	0.0141.502	-	01-45681	0.3431.742	-	-
10-24234-2 Obsolete	F6B-902	09-45825	09-812B-1**	Obsolete	0.0279.032	0.2233.252	01-45315	01-45312-1	0.0141.502	-	01-45681	0.3431.742	-	-
10-24235-1 Not in production	F7B-9	09-45590	09-1028B*	01-42679	01-46794-01	09-0.2247.050	01-42445	01-42441	01-46794-05	01-42443	Obsolete	0.3431.486	0.2233.002	-
10-24235-2 Not in production	F7B-903	09-45590	09-1028B*	01-42442	01-46794-07	09-0.2247.050	01-42445	01-42441	01-46794-05	01-42443	Obsolete	0.3431.486	0.2233.002	-
10-24235-3	F7B-9	09-45590	09-1028B*	01-42679	01-46794-01	09-0.2247.050	01-42445	01-42441	01-46794-05	01-42443	01-35202	0.3431.486	0.2233.002	-
10-24236-1/-2 Obsolete, repl. by 10-24453-04/-05	TA3P10-19 12V	-	09-1052S-9*	-	-	0.2233.007	37-3206217	01-35189	Obsolete	37-3206221	-	-	-	Obsolete
10-24239-1 Customer branded	F9B-9	09-45581	09-802B	01-43137	01-46794-02	09-0.2247.051	01-42424	01-42422-1	0.0144.003	01-42423	01-35212	0.3431.701	0.2233.016	-
10-24239-2	F9B-9	09-45581	09-802B	01-43137	01-46794-02	09-0.2247.051	01-42424	01-42422-1	0.0144.003	01-42423	01-35212	0.3431.701	0.2233.016	-
10-24240-1/-2 Obsolete	T50AL-1 12/24V	-	Obsolete	-	-	09-0.2247.010	0.2173.459	Obsolete	Obsolete	-	-	-	-	Obsolete
10-24244-1 Obsolete	F7B-9	09-45592	09-1028B*	01-42679	01-46794-01	0.2233.001	01-42445	01-42441	0.0279.033	-	01-45753	0.3431.483	0.2233.001	-
10-24244-2 Obsolete	F7B-903	09-45592	09-1028B*	01-42442	01-46794-07	0.2233.001	01-42445	01-42441	0.0279.033	-	01-45753	0.3431.483	0.2233.001	-
10-24253-1	F7B-902	09-45590	09-1028B*	01-42584	01-46794-06	09-0.2247.050	01-42445	01-42441	01-46794-05	01-42443	01-35220	0.3431.523	0.2233.017	-
10-24253-2	F7B-9	09-45590	09-1028B*	01-42679	01-46794-01	09-0.2247.050	01-42445	01-42441	01-46794-05	01-42443	01-35220	0.3431.523	0.2233.017	-
10-24253-3	F7B-9	09-45590	09-1028B*	01-42679	01-46794-14	09-0.2247.050	01-42445	01-46431	01-46794-13	01-42443	01-35220	0.3431.523	0.2233.017	-

A - parts no. 1, 4, 5, 7 included front
 ** - shaft drive end
 *** - included in service kit
 **** - back
 ***** -

Flexible Impeller Pumps

Part no.	Pump type	Service kit	Impeller	Cam	3	4	5	6	7	8	9	10	11	Clutch or Motor
					Camscrew	Seal	Gasket	Endcover	Endcover screw	Wearplate	Shaft	Bearing	Bearing seal	
10-24268-1 Not in production	F5B-9	09-45585	09-1027B-1*	01-42397	01-46794-05	0.2233.001	01-42401	01-42398	0.0279.501	01-42399	01-45821	0.3431.483	0.2233.001 ***	-
10-24268-2 Customer branded	F5B-902	09-45585	09-1027B-1*	01-45014	0.0279.032	0.2233.001	01-42401	01-42398	0.0279.501	01-42399	01-45821	0.3431.483	0.2233.001 ***	-
10-24268-3 Customer branded	F5B-902	09-45585	09-1027B-1*	01-45014	0.0279.032	0.2233.001	01-45933	01-42398	0.0279.501	01-42399	01-45821	0.3431.483	0.2233.001 ***	-
10-24268-4	F5B-9	09-45585	09-1027B-1*	01-42397	01-46794-05	0.2233.001	01-42401	01-42398	0.0279.501	01-42399	01-45821	0.3431.483	0.2233.001 ***	-
10-24268-5 Not in production	F5B-902	09-45585	09-1027B-1*	01-45014	0.0279.032	0.2233.001	01-42401	01-42398	0.0279.501	01-42399	01-45821	0.3431.483	0.2233.001 ***	-
10-24277-1 Customer branded	F7B-9	09-45592	09-1028B*	01-42679	01-46794-07	0.2233.001	01-42445	01-42441	0.0141.502	-	01-45844	0.3431.483	0.2233.001 ***	-
10-24277-2 Customer branded	F7B-902	09-45592	09-1028B*	01-42584	01-46794-06	0.2233.001	01-42445	01-42441	0.0141.502	-	01-45844	0.3431.483	0.2233.001 ***	-
10-24277-3	F7B-9	09-45592	09-1028B*	01-42679	01-46794-07	0.2233.001	01-42445	01-42441	0.0141.502	-	01-45844	0.3431.483	0.2233.001 ***	-
10-24277-4 Not in production	F7B-902	09-45592	09-1028B*	01-42584	01-46794-06	0.2233.001	01-42445	01-42441	0.0141.502	-	01-45844	0.3431.483	0.2233.001 ***	-
10-24277-5 Customer branded	F7B-9	09-45592	09-1028B*	01-42679	01-46794-07	0.2233.001	01-46397	01-42441	0.0141.502	-	01-45844	0.3431.483	0.2233.001 ***	-
10-24280-1 Obsolete	F7B-903	09-45592	09-1028B*	01-42442	01-46794-07	0.2233.001	01-42445	01-42441	0.0279.033	-	Obsolete	0.3431.483	0.2233.001 ***	-
10-24280-2 Obsolete	F7B-9	09-45592	09-1028B*	01-42679	01-46794-01	0.2233.001	01-42445	01-42441	0.0279.033	-	Obsolete	0.3431.742	0.2233.001 ***	-
10-24290-1	F4B-9	09-45872	09-810B-1*	01-45660	0.0279.501	0.2233.251	01-45284	01-45282	0.0279.501	-	01-45658	0.3431.748	-	-
10-24290-2 Not in production	F4B-903	09-45872	09-810B-1*	Obsolete	0.0279.501	0.2233.251	01-45284	01-45282	0.0279.501	-	01-45658	0.3431.748	-	-
10-24290-3 Not in production	F4B-902	09-45872	09-810B-1*	01-45084	0.0279.501	0.2233.251	01-45284	01-45282	0.0279.501	-	01-45658	0.3431.748	-	-
10-24302-01	F6B-9	09-45825	09-812B-1**	01-45670	0.0279.033	0.2233.252	01-45315	01-45312-1	0.0141.502	-	01-45681	0.3431.742	-	-
10-24302-02 Not in production	F6B-902	09-45825	09-812B-1**	Obsolete	0.0279.032	0.2233.252	01-45315	01-45312-1	0.0141.502	-	01-45681	0.3431.742	-	-
10-24305-01 Obsolete	F7B-903	09-45592	09-1028B*	01-42442	01-46794-07	0.2233.001	01-42445	01-42441	0.0279.033	-	Obsolete	0.3431.742	0.2233.001 ***	-
10-24308-01	F9B-9	09-45920	09-814B	01-45173	01-46794-09	09-0.2247.008	01-45354	01-35284	0.0138.134	01-42423	01-35282	0.3431.684	0.2234.006	-

A - parts no. 1, 4, 5, 7 included front * - gasket included ** - shaft drive end *** - included in service kit **** - back ***** -

Flexible Impeller Pumps

Part no.	Pump type	Service kit	Impeller	Cam	3	4	5	6	7	8	9	10	11	Clutch or Motor
		A	1	2	Camscrew	Seal	Gasket	Endcover	Endcover screw	Wearplate	Shaft	Bearing	Bearing seal	
Customer branded														
10-24308-02	F9B-905	09-45920	09-814B	01-45172	01-46794-09	09-0.2247008	01-45354	01-35284	0.0138.134	01-42423	01-35282	0.3431.684	0.2233.006	-
Customer branded														
10-24308-03	F9B-902	09-45920	09-814B	01-46230	01-46794-11	09-0.2247008	01-45354	01-35284	0.0138.134	01-42423	01-35282	0.3431.684	0.2233.006	-
Customer branded														
10-24315-01	F8B-903	-	09-819B	Obsolete	01-46794-09	09-0.2247008	01-45354	01-42422-1	0.0138.134	01-42423	Obsolete	0.3431.525	0.2233.008	-
Obsolete														
10-24316-01	F6B-9	09-45825	09-812B-1**	01-45670	0.0279.033	0.2233.252	01-45315	01-45312-1	0.0141.502	-	01-45681	0.3431.742	-	-
10-24316-02	F6B-902	09-45825	09-812B-1**	Obsolete	0.0279.032	0.2233.252	01-45315	01-45312-1	0.0141.502	-	01-45681	0.3431.742	-	-
Not in production														
10-24318-01	F5B-905	09-45585	09-1027B-1*	01-45976	01-46794-05	0.2233.001	01-42401	01-42398	0.0279.500	01-42399	01-45978	0.3431.761	-	-
10-24319-01	F4B-9	09-45587	09-810B-1*	01-42389	01-46794-03	0.2233.010	01-45284	01-45282	0.0279.501	-	01-45993	0.3431.441	0.2233.010	-
Not in production													***	-
10-24319-02	F4B-903	09-45587	09-810B-1*	01-45288	01-46794-03	0.2233.010	01-45284	01-45282	0.0279.501	-	01-45993	0.3431.441	0.2233.010	-
Not in production													***	-
10-24319-03	F4B-902	09-45587	09-810B-1*	01-45084	0.0279.501	0.2233.010	01-45284	01-45282	0.0279.501	-	01-45993	0.3431.441	0.2233.010	-
Not in production													***	-
10-24321-01	F4B-9	09-45587	09-810B-1*	01-42389	01-46794-03	0.2233.010	01-45284	01-45282	0.0279.501	-	01-35293	0.3431.441	0.2233.010	-
Not in production													***	-
10-24321-02	F4B-903	09-45587	09-810B-1*	01-45288	01-46794-03	0.2233.010	01-45284	01-45282	0.0279.501	-	01-35293	0.3431.441	0.2233.010	-
Not in production													***	-
10-24321-03	F4B-902	09-45587	09-810B-1*	01-45084	0.0279.501	0.2233.010	01-45284	01-45282	0.0279.501	-	01-35293	0.3431.441	0.2233.010	-
Not in production													***	-
10-24325-01	F5B-9	09-45585	09-1027B-1*	01-42397	01-46794-05	0.2233.001	01-42401	01-42398	0.0279.500	-	Obsolete	0.3431.761	-	-
Obsolete														
10-24325-02	F5B-902	09-45585	09-1027B-1*	01-45014	0.0279.032	0.2233.001	01-42401	01-42398	0.0279.500	-	Obsolete	0.3431.761	-	-
Obsolete														
10-24326-01	F4B-9	09-45587	09-810B-1*	01-42389	01-46794-03	0.2233.010	01-45284	01-45282	0.0279.501	-	01-35293	0.3431.441	0.2233.010	-
10-24326-02	F4B-903	09-45587	09-810B-1*	01-45288	01-46794-03	0.2233.010	01-45284	01-45282	0.0279.501	-	01-35293	0.3431.441	0.2233.010	-
Not in production													***	-
10-24326-03	F4B-902	09-45587	09-810B-1*	01-45084	0.0279.501	0.2233.010	01-45284	01-45282	0.0279.501	-	01-35293	0.3431.441	0.2233.010	-
Not in production													***	-

A - parts no. 1, 4, 5, 7 included front * - gasket included ** - shaft drive end *** - included in service kit **** - back ***** -

Flexible Impeller Pumps

Part no.	Pump type	Service kit	Impeller	Cam	3	4	5	6	7	8	9	10	11
				Cam	Camscrew	Seal	Gasket	Endcover	Endcover screw	Wearplate	Shaft	Bearing	Bearing seal
A	1	2											
10-24329-11 Obsolete	F7B-903	09-45592	09-1028B*	01-42442	01-46794-07	0.2233.001	01-42445	01-42441	0.0279.033	-	Obsolete	0.3431.483	0.2233.001 ***
10-24334-01	F5B-9	09-45585	09-1027B-1*	01-42397	01-46794-05	0.2233.001	01-42401	01-42398	0.0141.700	01-42399	01-35308	0.3431.761	-
10-24334-02 Not in production	F5B-902	09-45585	09-1027B-1*	01-45014	0.0279.032	0.2233.001	01-42401	01-42398	0.0279.500	01-42399	01-35308	0.3431.761	-
10-24335-01	F4B-9	09-45587	09-810B-1*	01-42389	01-46794-03	0.2233.010	01-45284	01-45282	0.0279.501	-	01-46046	0.3431.441	0.2233.010 ***
10-24336-01 Obsolete	F4B-9	09-45587	09-810B-1*	01-42389	01-46794-03	0.2233.010	01-45284	01-45282	0.0141.700	-	01-35293	0.3431.441	0.2233.010 ***
10-24336-02 Obsolete	F4B-903	09-45587	09-810B-1*	01-45288	01-46794-03	0.2233.010	01-45284	01-45282	0.0279.501	-	01-35293	0.3431.441	0.2233.010 ***
10-24336-03 Obsolete	F4B-902	09-45587	09-810B-1*	01-45084	0.0279.501	0.2233.010	01-45284	01-45282	0.0279.501	-	01-35293	0.3431.441	0.2233.010 ***
10-24338-01 Customer branded	F7B-9	09-45592	09-1028B*	01-42679	01-46794-01	0.2233.001	01-42445	01-42441	0.0279.033	-	01-46469	0.3431.742	0.2233.001 ***
10-24338-02 Obsolete	F7B-9	09-45592	09-1028B*	01-42679	01-46794-01	0.2233.001	01-42445	01-42441	0.0279.033	-	01-46469	0.3431.742	0.2233.001 ***
10-24341-01	F4B-9	09-45587	09-810B-1*	01-42389	01-46794-03	0.2233.010	01-45284	01-45282	0.0279.501	-	01-45353	0.3431.441	0.2233.010 ***
10-24341-02 Obsolete	F4B-903	09-45587	09-810B-1*	01-45288	01-46794-03	0.2233.010	01-45284	01-45282	0.0279.501	-	01-45353	0.3431.441	0.2233.010 ***
10-24341-03 Obsolete	F4B-902	09-45587	09-810B-1*	01-45084	0.0279.501	0.2233.010	01-45284	01-45282	0.0279.501	-	01-45353	0.3431.441	0.2233.010 ***
10-24349-01	F7B-9	09-45592	09-1028B*	01-42679	01-46794-01	0.2233.001	01-42445	01-42441	0.0279.033	-	01-46092	0.3431.742	0.2233.001 ***
10-24365-01	F7B-9	09-45590	09-1028B*	01-42679	01-46794-01	09-0.2247050	01-42445	01-42441	01-46794-05	01-42443	01-35220	0.3431.523	0.2233.017 ***
10-24365-02 Customer branded	F7B-9	09-45590	09-1028B*	01-42679	01-46794-01	09-0.2247050	01-42445	01-42441	01-46794-05	01-42443	01-35220	0.3431.523	0.2233.017 ***
10-24372-01 Customer branded	F5B-9	09-45808	09-1027B-1*	01-45329	0.0279.033	0.2233.001	01-45315	01-45312-1	0.0141.502	-	04-46238	0.3431.754	-
10-24386-01 Obsolete	F7B-9	09-45592	09-1028B*	01-42679	01-46794-01	0.2233.001	01-42445	01-42441	0.0279.033	-	01-46195	0.3431.742	0.2234.482 ***
10-24390-01 Obsolete	F7B-9	09-45592	09-1028B*	01-42679	01-46794-01	0.2233.001	01-42445	01-42441	0.0279.033	-	Obsolete	0.3431.483	0.2233.001 ***
10-24394-01	F7B-9	09-45592	09-1028B*	01-42679	01-46794-07	0.2233.001	01-42445	01-42441	0.0141.502	-	01-45844	0.3431.483	0.2233.001 ***

A - parts no. 1, 4, 5, 7 included front * - gasket included ** - shaft drive end *** - included in service kit **** - back ***** -

Flexible Impeller Pumps

Part no.	Pump type	Service kit	Impeller	Cam	3	4	5	6	7	8	9	10	11	Clutch or Motor
					Camscrew	Seal	Gasket	Endcover	Endcover screw	Wearplate	Shaft	Bearing	Bearing seal	
Obsolete, repl. by 10-24524-01														
10-24394-02 Obsolete	F7B-902	09-45592	09-1028B*	01-46242	01-46794-06	0.2233.001	01-42445	01-42441	0.0141.502	-	01-45844	0.3431.483	0.2233.001 ***	-
10-24394-03 Obsolete, repl. by 10-24524-03	F7B-9	09-45592	09-1028B*	01-42679	01-46794-07	0.2233.001	01-46397	01-42441	0.0141.502	-	01-45844	0.3431.483	0.2233.001 ***	-
10-24398-01	F7B-9	09-45592	09-1028B*	01-42679	01-46794-01	0.2233.001	01-42445	01-42441	0.0279.033	-	01-35670	0.3431.483	0.2233.001 ***	-
10-24398-02	F7B-9	09-45592	09-1028B*	01-42679	01-46794-01	0.2233.001	01-42445	01-42441	0.0279.033	-	01-35670	0.3431.483	-	-
10-24412-01 Obsolete, repl. by 10-24562-01	F6B-9	09-46172	09-812B-1**	01-45670	0.0279.033	0.2233.001	01-45315	01-45312-1	0.0141.502	-	01-46268	0.3431.444	0.2233.001 ***	-
10-24412-02 Obsolete, repl. by 10-24562-01	F6B-9	09-46172	09-812B-1**	01-45670	0.0279.033	0.2233.001	01-45315	01-45312-1	0.0141.502	-	01-46268	0.3431.444	0.2233.001 ***	-
10-24413-01	F75B-9	-	09-821B	01-46146	01-46794-12	09-0.2247008	01-46286	01-46285	0.0141.502	01-42443	01-35685	0.3431.001/ 0.3431.044	0.2233.351	-
10-24413-02 Customer branded	F75B-9	-	09-821B	01-46146	01-46794-12	09-0.2247008	01-46286	01-46285	0.0141.502	01-42443	01-35685	0.3431.001/ 0.3431.044	0.2233.351	-
10-24428-01	F7B-9	09-45592	09-1028B*	01-42679	01-46794-01	0.2233.001	01-42445	01-42441	0.0279.033	-	01-45044	0.3431.742	0.2233.001 ***	-
10-24430-01 Customer branded	F9B-9	-	09-814B	01-45018	01-46794-02	09-0.2247051	01-42424	01-42422-1	0.0144.003	01-42423	01-35698-1	0.3431.684	0.2233.016	-
10-24431-01 Obsolete	F7B-9	09-45592	09-1028B*	01-42679	01-46794-01	0.2233.001	01-42445	01-42441	0.0279.033	-	01-45248	0.3431.483	0.2233.001	-
10-24432-01 Obsolete, repl. by 10-24563-01	F6B-9	09-46172	09-812B-1**	01-45670	0.0279.033	0.2233.001	01-45315	01-45312-1	0.0141.502	-	01-35697	0.3431.444	0.2233.001 ***	-
10-24432-02 Obsolete, repl. by 10-24563-01	F6B-9	09-46172	09-812B-1**	01-45670	0.0279.033	0.2233.001	01-45315	01-45312-1	0.0141.502	-	01-35697	0.3431.444	0.2233.001 ***	-
10-24445-01	F7B-9	09-45590	09-1028B*	01-42679	01-46794-01	09-0.2247050	01-42445	01-42441	01-46794-05	01-42443	01-35713	0.3431.484	0.2233.350	-
10-24451-01	F5B-9	09-45583	09-1027B*	01-42397	01-46794-05	09-0.2247050	01-42401	01-42398	01-46794-04	01-42399	01-35713	0.3431.484	0.2233.350	-
10-24453-01	TA3P10-1907 12V09-45595	09-45595	09-1052S-9*	-	-	0.2233.007	37-3206217	01-35719-2	0.0142.737	37-3206221	-	-	-	01-24466-01
10-24453-02	TA3P10-1907 24V09-45595	09-45595	09-1052S-9*	-	-	0.2233.007	37-3206217	01-35719-2	0.0142.737	37-3206221	-	-	-	01-24466-02
10-24453-04	TA3P10-19 12V	09-45595	09-1052S-9*	-	-	0.2233.007	37-3206217	01-35719-1	0.0142.737	37-3206221	-	-	-	01-24466-01
10-24453-05	TA3P10-19 24V	09-45595	09-1052S-9*	-	-	0.2233.007	37-3206217	01-35719-1	0.0142.737	37-3206221	-	-	-	01-24466-02
10-24461-01	F5B-9	09-45808	09-1027B-1*	01-45329	0.0279.033	0.2233.252	01-45315	01-45312-1	0.0142.737	-	01-45681	0.3431.742	-	-

A - parts no. 1, 4, 5, 7 included front * - gasket included ** - shaft drive end *** - included in service kit **** - back ***** -

Flexible Impeller Pumps

Part no.	Pump type	Service kit	Impeller	Cam	3	4	5	6	7	8	9	10	11	Clutch or Motor
A	1	2	Cam	Camscrew	Seal	Gasket	Endcover	Endcover screw	Wearplate	Shaft	Bearing	Bearing seal	Clutch or Motor	
Customer branded														
10-24463-01	F4B-903	09-45905	09-1026B-1*	01-45288	01-46794-03	0.2233.010	01-45284	01-45282	0.0279.501	-	01-46492	0.3431.441	0.2233.010	- ***
Customer branded, replaced by 10-24571-01														
10-24465-01	F4B-9	09-45905	09-1026B-1*	01-42389	01-46794-03	0.2233.010	01-45284	01-45282	0.0279.501	-	01-46491	0.3431.441	0.2233.010	- ***
Customer branded, replaced by 10-24572-01														
10-24475-01	F7B-902	09-45592	09-1028B*	01-42584	01-46794-06	0.2233.001	01-42445	01-42441	0.0279.033	-	01-46476	0.3431.742	0.2233.001	- ***
Not in production														
10-24475-02	F7B-903	09-45592	09-1028B*	01-42442	01-46794-07	0.2233.001	01-42445	01-42441	0.0279.033	-	01-46476	0.3431.742	0.2233.001	- ***
10-24493-01	F6B-9	09-46693	09-812B-1**	01-46502	0.0279.033	0.2233.001	0.2173.475	01-46535	0.0141.502	-	01-46268-2	0.3431.444	0.2233.001	- ***
Customer branded														
10-24493-02	F6B-9	09-46693	09-812B-1**	01-46502	0.0279.033	0.2233.001	0.2173.475	01-46535	0.0141.502	-	01-46268-2	0.3431.444	0.2233.001	- ***
Customer branded														
10-24508-01	F5B-9	09-46694-1	09-1027B-1*	-	-	0.2233.022	0.2173.475	01-46535	0.0141.503	01-46532	01-46531	0.3431.483	0.2233.001	-
Obsolete, repl by 10-24508-03														
10-24508-02	F5B-9	09-46694-2	09-1027B-1*	-	-	09-0.2247050	0.2173.475	01-46535	0.0141.503	01-46532	01-46531	0.3431.483	0.2233.001	-
Obsolete														
10-24508-03	F5B-9	-	09-1027B-1*	-	-	0.2233.022	0.2173.475	01-46535	0.0141.503	01-46532	01-46531	0.3431.483	0.2233.001	-
Customer branded														
10-24508-04	F5B-9	-	09-1027B-1*	-	-	09-0.2247050	0.2173.475	01-46535	0.0141.503	01-46532	01-46531	0.3431.483	0.2233.001	-
Customer branded														
10-24509-01	F4B-903	09-45587	09-810B-1*	-	-	0.2233.010	0.2173.476	01-42398	0.0141.700	-	01-46541	0.3431.760/ 0.3431.748	-	-
Customer branded														
10-24509-02	F4B-902	09-45587	09-810B-1*	-	-	0.2233.010	0.2173.476	01-42398	0.0141.700	-	01-46541	0.3431.760/ 0.3431.748	-	-
Customer branded														
10-24512-01	F4B-19 12V	09-46600	09-824P-9*	-	-	0.2233.007	0.2173.476	01-42398	0.0279.501	-	-	-	-	01-24452-1
Replaced by 10-24689-01														
10-24512-02	F4B-19 24V	09-46600	09-824P-9*	-	-	0.2233.007	0.2173.476	01-42398	0.0279.501	-	-	-	-	01-24452-2
Replaced by 10-24689-02														
10-24512-03	F4B-1907 12V	09-46600	09-824P-9*	-	-	0.2233.007	0.2173.476	01-42398	0.0279.501	-	-	-	-	01-24452-1
Replaced by 10-24689-03														
10-24512-04	F4B-1907 24V	09-46600	09-824P-9*	-	-	0.2233.007	0.2173.476	01-42398	0.0279.501	-	-	-	-	01-24452-2
Replaced by 10-24689-04														
10-24514-01	F4B-9	09-45587	09-810B-1*	01-42389	01-46794-03	0.2233.010	01-45284	01-45282	0.0279.501	-	01-46563	0.3431.441	-	-

A - parts no. 1, 4, 5, 7 included front * - gasket included ** - shaft drive end *** - included in service kit **** - back ***** -

Flexible Impeller Pumps

Part no.	Pump type	Service kit	Impeller	Cam	3	4	5	6	7	8	9	10	11	Clutch or Motor
A					Cam	Camscrew	Gasket	Endcover	Endcover screw	Wearplate	Shaft	Bearing	Bearing seal	
10-24515-01 Customer branded	F6B-9	09-46693	09-812B-1**	-	-	0.2233.001	0.2173.475	01-46556	0.0279.301	-	01-46596	0.3431.742	0.2234.014	-
10-24516-01	F3B-19 12V	09-45595	09-1052S-9*	-	-	0.2233.007	0.2173.436	01-43131	0.0279.501	-	-	-	-	01-35285-01
10-24516-02	F3B-19 24V	09-45595	09-1052S-9*	-	-	0.2233.007	0.2173.436	01-43131	0.0279.501	-	-	-	-	01-35285-02
10-24516-03	F3B-1907 12V	09-45595	09-1052S-9*	-	-	0.2233.007	0.2173.436	01-43131	0.0279.501	-	-	-	-	01-35285-01
10-24516-04	F3B-1907 24V	09-45595	09-1052S-9*	-	-	0.2233.007	0.2173.436	01-43131	0.0279.501	-	-	-	-	01-35285-02
10-24516-05	F3B-19 12V	09-45595	09-1052S-9*	-	-	0.2233.007	0.2173.436	01-46008	0.0279.501	-	-	-	-	01-35285-01
Not in production														
10-24516-06	F3B-19 24V	09-45595	09-1052S-9*	-	-	0.2233.007	0.2173.436	01-46008	0.0279.501	-	-	-	-	01-35285-02
Not in production														
10-24524-01 Obsolete, repl. by 10-24524-02	F7B-9	09-45592	09-1028B*	-	-	0.2233.001	0.2172.012	Cust. branded	0.0141.502	-	01-45844	0.3431.483	0.2233.001	-
10-24524-02 Customer branded	F7B-9	09-45592	09-1028B*	-	-	0.2233.001	0.2172.012	Cust. branded	0.0141.502	01-46816	01-45844	0.3431.483	0.2233.001	***
10-24524-03 Obsolete, repl. by 10-24524-05	F7B-9	09-45592	09-1028B*	-	-	0.2233.001	0.2172.012	Cust. branded	0.0141.502	-	01-45844	0.3431.483	0.2233.001	-
10-24524-04 Customer branded	F7B-9	09-45592	09-1028B*	-	-	0.2233.001	0.2172.012	Cust. branded	0.0141.502	01-46816-2	01-45844	0.3431.483	0.2233.001	***
10-24524-05 Customer branded	F7B-9	09-45592	09-1028B*	-	-	0.2233.001	0.2172.012	Cust. branded	0.0141.502	01-46816	01-45844	0.3431.483	0.2233.001	-
10-24535-01 Customer branded	F7B-9	-	09-1028B*	-	-	09-0.2247050	0.2172.012	01-46648-1	0.0141.502	01-46647	01-35838	0.3431.523	0.2233.017	-
10-24542-01	F7B-903	09-45592	09-1028B*	01-42442	01-46794-07	0.2233.001	01-42445	01-42441	0.0138.987	-	01-46674	0.3431.742	0.2234.482	-
10-24551-01	F3B-19 230V	09-45595	09-1052S-9	-	-	0.2233.107	0.2173.436	01-43141	0.0279.501	-	-	-	-	01-35848-1
10-24551-02	F3B-19 110V	09-45595	09-1052S-9	-	-	0.2233.107	0.2173.436	01-43141	0.0279.501	-	-	-	-	01-35848-2
10-24551-03	F3B-19 230V	09-45595	09-1052S-9	-	-	0.2233.107	0.2173.436	01-43141	0.0279.501	-	-	-	-	01-35848-1
10-24551-04	F3B-19 110V	09-45595	09-1052S-9	-	-	0.2233.107	0.2173.436	01-43141	0.0279.501	-	-	-	-	01-35848-2
10-24554-01	F2P10-19 230V	09-45594	09-45594	-	-	0.2234.402	0.2172.506	21-4945	0.0140.001	21-4944**** 21-4946****	-	-	-	01-35848-1
10-24556-01	F7B-5001 MC	09-45592	09-1028B*	01-42679	01-46794-01	0.2233.001	01-42445	01-42441	0.0279.033	-	01-35865	0.3431.742	-	0.3454.001 = 12V 2xA

A - parts no. 1, 4, 5, 7 included front * - gasket included ** - shaft drive end *** - included in service kit **** - back ***** -

Flexible Impeller Pumps

Part no.	Pump type	Service kit	Impeller	Cam	3	4	5	6	7	8	9	10	11	Clutch or Motor
		A	1	2	Camscrew	Seal	Gasket	Endcover	Endcover screw	Wearplate	Shaft	Bearing	Bearing seal	
10-24556-02	F7B-50017 MC	09-45592	09-1028B*	01-42679	01-46794-01	0.2233.001	01-42445	01-42441	0.0279.033	-	01-35865	0.3431.742	-	0.3454.001 = 24V 2xA
Obsolete														0.3454.003 = 12V 1xB
														0.3454.004 = 24V 1xB
10-24559-01	F8B-5001 MC	09-45592	09-819B	01-42680	01-46794-02	09-0.2247.008	01-42424	01-42422-1	0.0138.134	01-42423	01-35875	0.3431.780	-	0.3454.001 = 12V 2xA
Obsolete														0.3454.002 = 24V 2xA
														0.3454.003 = 12V 1xB
														0.3454.004 = 24V 1xB
10-24559-02	F8B-50017 MC	09-45592	09-819B	01-42680	01-46794-02	09-0.2247.008	01-42424	01-42422-1	0.0138.134	01-42423	01-35875	0.3431.780	-	0.3454.001 = 12V 2xA
Obsolete														0.3454.002 = 24V 2xA
														0.3454.003 = 12V 1xB
														0.3454.004 = 24V 1xB
10-24562-01	F6B-9	-	09-812B-1**	01-45670	0.0279.033	0.2233.001	0.2173.475	01-46723	0.0141.502	-	01-46268	0.3431.444	0.2233.001	0.3454.001 = 12V 2xA
Customer branded														0.3454.002 = 24V 2xA
10-24562-02	F6B-9	-	09-812B-1**	01-45670	0.0279.033	0.2233.001	0.2173.475	01-46723	0.0141.502	-	01-46268	0.3431.444	0.2233.001	0.3454.003 = 12V 1xB
Customer branded														0.3454.004 = 24V 1xB
10-24563-01	F6B-9	-	09-812B-1**	01-45670	0.0279.033	0.2233.001	0.2173.475	01-46723	0.0141.502	-	01-35697	0.3431.444	0.2233.001	0.3454.001 = 12V 2xA
Customer branded														0.3454.002 = 24V 2xA
10-24565-01	F3S-19 230V	09-45595	09-1052S-9	-	-	0.2233.107	0.2173.436	01-46729	0.0279.501	-	-	-	-	0.3454.003 = 12V 1xB
Customer branded														0.3454.004 = 24V 1xB
10-24565-02	F3S-19 110V	09-45595	09-1052S-9	-	-	0.2233.107	0.2173.436	01-46729	0.0279.501	-	-	-	-	0.3454.001 = 12V 2xA
Customer branded														0.3454.002 = 24V 2xA
10-24567-01	F7B-9 03	09-45592	09-1028B*	01-42442	01-46794-07	0.2233.001	0.2173.402	01-42441	0.0138.987	-	01-35878	0.3431.742	0.2234.482	0.3454.003 = 12V 1xB
10-24568-01	F6B-9	-	09-812B-1**	-	-	0.2233.001	0.2173.475	01-46556	0.0279.301	-	01-46596	0.3431.742	0.2234.014	0.3454.004 = 24V 1xB

A - parts no. 1, 4, 5, 7 included front
 * - gasket included
 ** - shaft drive end
 *** - included in service kit
 **** - back
 ***** -

Flexible Impeller Pumps

Part no.	Pump type	Service kit	Impeller	Cam	3	4	5	6	7	8	9	10	11
				Cam	Camscrew	Seal	Gasket	Endcover	Endcover screw	Wearplate	Shaft	Bearing	Bearing seal
10-24569-01	F35B-8	09-46840	09-808B-1*	01-42910	01-46794-03	09-0.2247021	0.2173.440	01-46739-2	0.0141.700	01-46676	01-46735-1	0.3431.748	-
10-24569-03	F35B-802	09-46840	09-808B-1*	01-42415	01-46794-10	09-0.2247021	0.2173.440	01-46739-2	0.0141.700	01-46676	01-46735-1	0.3431.748	-
10-24569-09	F35B-8027	09-46840	09-808B-1*	01-42415	01-46794-10	09-0.2247021	0.2173.440	01-46739-2	0.0141.700	01-46676	01-46735-1	0.3431.748	-
10-24569-13	F35B-8	09-45589	09-808B-1*	01-42910	01-46794-03	0.2233.010	0.2173.440	01-46739-2	0.0141.700	01-46676	01-46735-1	0.3431.748	-
Obsolete, repl by 10-24569-01													
10-24569-15	F35B-802	09-45589	09-808B-1*	01-42415	01-46794-10	0.2233.010	0.2173.440	01-46739-2	0.0141.700	01-46676	01-46735-1	0.3431.748	-
Obsolete, repl by 10-24569-03													
10-24569-21	F35B-8027	09-45589	09-808B-1*	01-42415	01-46794-10	0.2233.010	0.2173.440	01-46739-2	0.0141.700	01-46676	01-46735-1	0.3431.748	-
Obsolete, repl by 10-24569-09													
10-24569-51	F35B-8007	09-46840	09-808B-1*	01-42910	01-46794-03	09-0.2247021	0.2173.440	01-46739-2	0.0141.700	01-46676	01-46735-1	0.3431.748	-
10-24569-52	F35B-8007	09-45589	09-808B-1*	01-42910	01-46794-03	09-0.2247021	0.2173.440	01-46739-2	0.0141.700	01-46676	01-46735-1	0.3431.748	-
Obsolete, repl by 10-24569-51													
10-25469-53	F35B-8007	09-46840	09-808B-1*	01-42910	01-46794-03	09-0.2247021	0.2173.440	01-46739-2	0.0141.700	01-46676	01-46735-1	0.3431.748	-
Customer branded													
10-24569-54	F35B-8007	09-45589	09-808B-1*	01-42910	01-46794-03	0.2233.010	0.2173.440	01-46739-2	0.0141.700	01-46676	01-46735-1	0.3431.748	-
Customer branded													
10-24570-01	F4B-8	09-46841	09-810B-1*	01-42389	01-46794-04	09-0.2247021	0.2173.476	01-46007-2	0.0141.700	01-46737-2	01-46735-1	0.3431.748	-
10-24570-02	F4B-89	09-46842	09-810B-9	01-42389	01-46794-04	09-0.2247021	0.2173.476	01-46007-2	0.0141.700	01-46737-2	01-46735-1	0.3431.748	-
10-24570-07	F4B-8007	09-46841	09-810B-1*	01-42389	01-46794-04	09-0.2247021	0.2173.476	01-46007-2	0.0141.700	01-46737-2	01-46735-1	0.3431.748	-
10-24570-13	F4B-8	09-45587	09-810B-1*	01-42389	01-46794-04	0.2233.010	0.2173.476	01-46007-2	0.0141.700	01-46737-2	01-46735-1	0.3431.748	-
Obsolete, repl by 10-24570-01													
10-24570-14	F4B-89	09-45588	09-810B-9	01-42389	01-46794-04	0.2233.010	0.2173.476	01-46007-2	0.0141.700	01-46737-2	01-46735-1	0.3431.748	-
Obsolete, repl by 10-24570-02													
10-24570-19	F4B-8007	09-45587	09-810B-1*	01-42389	01-46794-04	0.2233.010	0.2173.476	01-46007-2	0.0141.700	01-46737-2	01-46735-1	0.3431.748	-
Obsolete, repl by 10-24570-07													
10-24570-51	F4B-8007	09-46841	09-810B-1*	01-42389	01-46794-04	09-0.2247021	0.2173.476	01-46007-2	0.0141.700	01-46737-2	01-46735-1	0.3431.748	-
10-24570-52	F4B-8007	09-45587	09-810B-1*	01-42389	01-46794-04	0.2233.010	0.2173.476	01-46007-2	0.0141.700	01-46737-2	01-46735-1	0.3431.748	-
Obsolete, repl by 10-24570-51													
10-24570-53	F4B-8	09-46841	09-810B-1*	01-42389	01-46794-04	09-0.2247021	0.2173.476	01-46007-2	0.0141.700	01-46737-2	01-46735-1	0.3431.748	-
Not in production													

A - parts no. 1, 4, 5, 7 included front * - gasket included ** - shaft drive end *** - included in service kit **** - back ***** -

Flexible Impeller Pumps

Part no.	Pump type	Service kit	Impeller	Cam	3	4	5	6	7	8	9	10	11
				Cam	Camscrew	Seal	Gasket	Endcover	Endcover screw	Wearplate	Shaft	Bearing	Bearing seal
10-24570-54 Obsolete, repl by 10-24570-53	F4B-8	09-45587	09-810B-1*	01-42389	01-46794-04	0.2233.010	0.2173.476	01-46007-2	0.0141.700	01-46737-2	01-46735-1	0.3431.748	-
10-24571-01	F5B-8	09-46843	09-1027B-1*	01-42397	01-46794-05	09-0.2247.022	0.2173.475	01-46747-2	0.0141.700	01-42399-2	01-46744	0.3431.742	-
10-24571-02	F5B-89	09-46844	09-1027B-9	01-42397	01-46794-05	09-0.2247.022	0.2173.475	01-46747-2	0.0141.700	01-42399-2	01-46744	0.3431.742	-
10-24571-03	F5B-802	09-46843	09-1027B-1*	01-45014	0.0279.032	09-0.2247.022	0.2173.475	01-46747-2	0.0141.700	01-42399-2	01-46744	0.3431.742	-
10-24571-13 Obsolete, repl by 10-24571-01	F5B-8	09-45585	09-1027B-1*	01-42397	01-46794-05	0.2233.012	0.2173.475	01-46747-2	0.0141.700	01-42399-2	01-46744	0.3431.742	-
10-24571-14 Obsolete, repl by 10-24571-02	F5B-89	09-45586	09-1027B-9	01-42397	01-46794-05	0.2233.012	0.2173.475	01-46747-2	0.0141.700	01-42399-2	01-46744	0.3431.742	-
10-24571-15 Obsolete, repl by 10-24571-02	F5B-802	09-45585	09-1027B-1*	01-45014	0.0279.032	0.2233.012	0.2173.475	01-46747-2	0.0141.700	01-42399-2	01-46744	0.3431.742	-
10-24571-51	F5B-8007	09-46843	09-1027B-1*	01-42397	01-46794-05	09-0.2247.022	0.2173.475	01-46747-2	0.0141.700	01-42399-2	01-46744	0.3431.742	-
10-24571-52 Obsolete, repl by 10-24571-51	F5B-8007	09-45585	09-1027B-1*	01-42397	01-46794-05	0.2233.012	0.2173.475	01-46747-2	0.0141.700	01-42399-2	01-46744	0.3431.742	-
10-24571-53 Not in production	F5B-8	09-46843	09-1027B-1*	01-42397	01-46794-05	09-0.2247.022	0.2173.475	01-46747-2	0.0141.700	01-42399-2	01-46744	0.3431.742	-
10-24571-54 Obsolete, repl by 10-24571-53	F5B-8	09-45585	09-1027B-1*	01-42397	01-46794-05	0.2233.012	0.2172.012	01-46747-2	0.0141.700	01-42399-2	01-46744	0.3431.742	-
10-24572-01	F7B-8	09-46845	09-1028B*	01-42679	01-46794-01	09-0.2247.022	0.2172.012	01-46648-3	0.0279.301	01-46798-2	01-46744	0.3431.742	-
10-24572-05	F7B-803	09-46845	09-1028B*	01-42442	01-46794-07	09-0.2247.022	0.2172.012	01-46648-3	0.0279.301	01-46798-2	01-46744	0.3431.742	-
10-24572-13 Obsolete, repl by 10-24572-01	F7B-8	09-45592	09-1028B*	01-42679	01-46794-01	0.2233.012	0.2172.012	01-46648-3	0.0279.301	01-46798-2	01-46744	0.3431.742	-
10-24572-17 Obsolete, repl by 10-24572-05	F7B-803	09-45592	09-1028B*	01-42442	01-46794-07	0.2233.012	0.2172.012	01-46648-3	0.0279.301	01-46798-2	01-46744	0.3431.742	-
10-24572-51	F7B-8007	09-46845	09-1028B*	01-42679	01-46794-01	09-0.2247.022	0.2172.012	01-46648-3	0.0279.301	01-46798-2	01-46744	0.3431.742	-
Obsolete, repl by 10-24572-51	F7B-8007	F7B-8007	09-45592	09-1028B*	01-42679	01-46794-01	0.2233.012	0.2172.012	01-46648-3	0.0279.301	01-46798-2	01-46744	0.3431.742
10-24572-53 Not in production	F7B-8	09-46845	09-1028B*	01-42679	01-46794-01	09-0.2247.022	0.2172.012	01-46648-3	0.0279.301	01-46798-2	01-46744	0.3431.742	-
10-24572-54 Obsolete, repl by 10-24572-53	F7B-8	09-45592	09-1028B*	01-42679	01-46794-01	0.2233.012	0.2172.012	01-46648-3	0.0279.301	01-46798-2	01-46744	0.3431.742	-
10-24577-13	F7B-5001	09-45592	09-1028B*	01-42679	01-46794-01	0.2233.012	0.2172.012	01-46648-3	0.0279.301	01-46798-2	01-46745	0.3431.742	-

A - parts no. 1, 4, 5, 7 included front
 * - gasket included
 ** - shaft drive end
 *** - included in service kit
 **** - back
 ***** -

Flexible Impeller Pumps

Part no.	Pump type	Service kit	Impeller	Cam	3	4	5	6	7	8	9	10	11	Clutch or Motor
				Cam	Camscrew	Seal	Gasket	Endcover	Endcover screw	Wearplate	Shaft	Bearing	Bearing seal	
Obsolete														
10-24577-19	F7B-50017	09-46592	09-1028B*	01-42679	01-46794-01	0.2233.012	0.2172.012	01-46648-3	0.0279.301	01-46798-2	01-46745	0.3431.742	-	0.3454.001 = 12V 2xA 0.3454.002 = 24V 2xA 0.3454.003 = 12V 1xB 0.3454.004 = 24V 1xB
Obsolete														
10-24577-98	F7B-50017	09-46868	09-1028B*	01-42679	01-46794-01	09-0.2247.022	0.2172.012	01-46648-3	0.0279.301	01-46798-2	01-46745	0.3431.742	-	0.3454.001 = 12V 2xA 0.3454.002 = 24V 2xA 0.3454.003 = 12V 1xB 0.3454.004 = 24V 1xB
10-24577-99	F7B-5001	09-46868	09-1028B*	01-42679	01-46794-01	09-0.2247.022	0.2172.012	01-46648-3	0.0279.301	01-46798-2	01-46745	0.3431.742	-	0.3454.001 = 12V 2xA 0.3454.002 = 24V 2xA 0.3454.003 = 12V 1xB 0.3454.004 = 24V 1xB
10-24578-03	F7B-5001-MC	09-46845	09-1028B*	01-42679	01-46794-01	09-0.2247.022	0.2172.012	01-46648-3	0.0279.301	01-46798-2	01-35894	0.3431.742	-	0.3454.001 = 12V 2xA 0.3454.002 = 24V 2xA 0.3454.003 = 12V 1xB 0.3454.004 = 24V 1xB
Obsolete														
10-24578-04	F7B-50017-MC	09-46845	09-1028B*	01-42679	01-46794-01	09-0.2247.022	0.2172.012	01-46648-3	0.0279.301	01-46798-2	01-35894	0.3431.742	-	0.3454.001 = 12V 2xA 0.3454.002 = 24V 2xA 0.3454.003 = 12V 1xB 0.3454.004 = 24V 1xB
Obsolete														

A - parts no. 1, 4, 5, 7 included front
 * - gasket included
 ** - shaft drive end
 *** - included in service kit
 **** - back
 ***** -

Flexible Impeller Pumps

Part no.	Pump type	Service kit	Impeller	Cam	3	4	5	6	7	8	9	10	11	Clutch or Motor
		A	1	2	Camscrew	Seal	Gasket	Endcover	Endcover screw	Wearplate	Shaft	Bearing	Bearing seal	
10-24580-01 Customer branded	F7B-9	-	09-1028B*	01-46899	01-46794-01	09-0.2247050	01-42445	01-42441	01-46794-05	01-42443	01-35897	0.3431.742	-	0.3454.003 = 12V 1xB 0.3454.004 = 24V 1xB
10-24591-01 Customer branded	F6B-9	-	09-812B-1*	01-45670	0.0279.033	0.2233.001	0.2173.475	01-46723	0.0141.502	-	01-35697	0.3431.444	-	
10-24592-01 Customer branded	F6B-9	-	09-812B-1*	01-45670	0.0279.033	0.2233.001	0.2173.475	01-46723	0.0141.502	-	01-35697	0.3431.444	-	
10-24593-01 Customer branded	F6B-9	-	09-812B-1*	01-45670	0.0279.033	0.2233.001	0.2173.475	01-46723	0.0141.502	-	01-46268	05-08-520	-	
10-24599-01 Customer branded	F7B-9	-	09-1028B	-	-	0.2233.252	0.2172.012	01-46648-1	0.0141.502	01-46816	01-46837	0.3431.778	-	
10-24609-01	F3S-19 1ph 230V	09-45595	09-1052S-9	-	-	0.2233.107	0.2173.436	01-46729	0.0279.501	-	-	-	-	01-35848-1
10-24609-02	F3S-19 1ph 110V	09-45595	09-1052S-9	-	-	0.2233.107	0.2173.436	01-46729	0.0279.501	-	-	-	-	01-35848-2
10-24621-01	F7B-9	-	09-1028B	01-42442	0.0279.033	09-0.2247022	0.2172.012	01-46648-3	0.0279.301	01-46798-2	01-35965-1	0.3431.742	0.2233.403	
10-24630-01	F7B-9	-	09-1028B	01-46899	0.0279.033	09-0.2247022	0.2172.012	01-46648-3	0.0279.301	01-46798-2	01-35964	0.3431.742	0.2233.403	
10-24630-02	F7B-9	-	09-1028B	01-46899-1	0.0279.033	09-0.2247022	0.2172.012	01-46648-3	0.0279.301	01-46798-2	01-35964	0.3431.742	0.2233.403	
10-24633-01 Customer branded	F6B-9	-	09-812B-1*	-	-	09-0.2247022	0.2173.475	01-46556	0.0141.502	01-46969	01-46964	0.3431.778	0.2234.016	
10-24637-01	F7B-9	-	09-1028B	01-46899	0.0279.033	09-0.2247022	0.2172.012	01-46648-3	0.0138.987	01-46798-2	01-35965-2	0.3431.742	-	
10-24638-01	F35B Duo	-	09-808B-1*	01-42415	01-46794-10	09-0.2247021	0.2173.440	01-46739-2	0.0141.700	01-46676	01-47053 01-47052	0.3431.748	-	
10-24638-02	F35B SWP	-	09-808B-1*	01-42415	01-46794-10	09-0.2247021	0.2173.440	01-46739-2	0.0141.700	01-46676	01-47053	0.3431.748	-	
10-24638-03	F35B FWP	-	09-808B-1*	01-42415	01-46794-10	09-0.2247021	0.2173.440	01-46739-2	0.0141.700	01-46676	01-47052	0.3431.748	-	
10-24654-01	F7B-903	-	09-1028B	01-42442	01-46794-10	0.2233.001	01-42445	01-42441	0.0279.033	-	-	0.3431.742	-	
10-24666-01 Customer branded	F7B-9	-	09-1028B	01-46899	0.0279.033	09-0.2247022	0.2172.012	01-46648-3	0.0279.301	01-46798-2	01-36044	0.3431.742	-	
10-24666-02 Customer branded	F7B-9	-	09-1028B	01-46899	0.0279.033	09-0.2247022	0.2172.012	01-46648-3	0.0279.301	01-46798-2	01-36045	0.3431.742	-	
10-24667-01 Customer branded	F7B-9	-	09-1028B	01-46899	0.0279.033	09-0.2247022	0.2172.012	01-46648-3	0.0279.301	01-46798-2	01-36046	0.3431.742	-	

A - parts no. 1, 4, 5, 7 included front * - gasket included ** - shaft drive end *** - included in service kit **** - back ***** -

Flexible Impeller Pumps

Part no.	Pump type	Service kit	Impeller	Cam	3	4	5	6	7	8	9	10	11	Clutch or Motor
A				2	Camscrew	Seal	Gasket	Endcover	Endcover screw	Wearplate	Shaft	Bearing	Bearing seal	
10-24689-01	F4B-19 12V	09-46600	09-824P-9	-	-	0.2233.007	0.2173.476	01-42398	0.0279.501	-	-	-	-	01-24676-01
10-24689-02	F4B-19 24V	09-46600	09-824P-9	-	-	0.2233.007	0.2173.476	01-42398	0.0279.501	-	-	-	-	01-24676-02
10-24689-03	F4B-1907 12V	09-46600	09-824P-9	-	-	0.2233.007	0.2173.476	01-42398	0.0279.501	-	-	-	-	01-24676-01
10-24689-04	F4B-1907 24V	09-46600	09-824P-9	-	-	0.2233.007	0.2173.476	01-42398	0.0279.501	-	-	-	-	01-24676-02
10-24690-01	F4B-11 12V BSP	-	09-824P-1	-	-	0.2233.007	0.2173.476	01-42398	0.0279.501	-	-	-	-	01-24676-01
10-24690-02	F4B-11 24V BSP	-	09-824P-1	-	-	0.2233.007	0.2173.476	01-42398	0.0279.501	-	-	-	-	01-24676-02
10-24690-03	F4B-11 12V NPTF	-	09-824P-1	-	-	-	0.2233.007	0.2173.476	01-42398	0.0279.501	-	-	-	-
10-24690-04	F4B-11 24V NPTF	-	09-824P-1	-	-	-	0.2233.007	0.2173.476	01-42398	0.0279.501	-	-	-	-
10-24707-01	F35B-902	-	09-808B-1*	01-42415	01-46794-10	0.2233.010	01-43240	01-43239	0.0279.501	01-45087	01-45543	0.3431.441	-	-
10-24727-01	F38B-19 12V	09-46600	09-824P-9	-	-	0.2233.007	0.2173.476	01-42398	0.0279.501	-	-	-	-	01-35285-01
10-24727-02	F38B-19 24V	09-46600	09-824P-9	-	-	0.2233.007	0.2173.476	01-42398	0.0279.501	-	-	-	-	01-35285-02
10-24727-03	F38B-1907 12V	09-46600	09-824P-9	-	-	0.2233.007	0.2173.476	01-42398	0.0279.501	-	-	-	-	01-35285-01
10-24727-04	F38B-1907 24V	09-46600	09-824P-9	-	-	0.2233.007	0.2173.476	01-42398	0.0279.501	-	-	-	-	01-35285-02
10-24734-04	F4B-9	-	09-810B-1*	-	-	0.2233.010	0.2173.476	01-46007-3	0.0141.700	-	01-36127	0.3431.748	-	-
Customer branded														
10-24734-05	F4B-9	-	09-810B-1*	-	-	0.2233.010	0.2173.476	01-46007-2	0.0141.700	-	01-36127	0.3431.748	-	-
Customer branded														
10-24748-01	F7B-9	-	09-1028B	01-46899	0.0279.033	09-0.2247022	0.2172.012	01-46648-3	0.0279.301	01-46798-2	01-36046	0.3431.742	-	-
Customer branded														
10-24749-01	F4B-9	-	09-810B-1*	01-45084	01-46794-10	09-0.2247021	0.2173.476	01-46007-2	0.0279.300	01-46737-2	Cust.branded	0.3431.748	0.2234.021	-
Customer branded														
10-24751-01	F4B-903	-	09-1026B-1*	01-45288	01-46794-03	0.2233.010	01-45284	01-45600	0.0279.300	-	01-46492	0.3431.441	-	-
Customer branded														

A - parts no. 1, 4, 5, 7 included front * - gasket included ** - shaft drive end *** - included in service kit **** - back ***** -

Flexible Impeller Pumps

Part no.	Pump type	Service kit	Impeller	Cam	3	4	5	6	7	8	9	10	11	Clutch or Motor
					Camscrew	Seal	Gasket	Endcover	Endcover screw	Wearplate	Shaft	Bearing	Bearing seal	
10-24752-01 Customer branded	F4B-9	-	09-1026B-1*	01-42389	01-46794-03	0.2233,010	01-45284	01-45600	0.0279,300	-	01-46491	0.3431,441	-	-
10-24753-01 Customer branded	F7B-9	-	09-1028B	01-46899	0.0279,033	09-0.2247,022	0.2172,012	01-46648-3	0.0279,301	01-46798-2	01-36141	0.3431,742	-	-
10-24760-01	F3B-19 12V	-	09-843S-9	-	-	0.2233,007	0.2173,436	01-43141	0.0279,501	-	-	-	-	04-24757-01
10-31917-1 Obsolete, repl. by 10-35098-2	F4B-9	-	09-843S-9	-	-	0.2233,007	0.2173,436	01-43141	0.0279,501	-	-	-	-	04-24757-02
10-31934-1 Obsolete, repl. by 10-35157-3	F4B-9	-	09-1026B-1*	01-42389	01-46794-04	0.2233,005	01-42391	01-42388-1	01-46794-03	-	Obsolete	-	-	-
10-32058-1	F5B-9	09-45904	09-806B-1*	01-42415	01-46794-03	0.2233,005	01-42417	Obsolete	01-46794-10	-	Obsolete	-	-	-
10-32256-1	F5B-9	09-45913	09-801B-1*	01-42397	01-46794-05	0.2233,001	01-42636	01-32064	01-46794-04	01-42399	01-42644	-	-	-
10-32280-1 Obsolete, repl. by 10-35157-3	F35B-9	09-45583	09-1027B-1*	01-42397	01-46794-05	09-0.2247,050	01-42401	01-42398	01-46794-04	01-42399	01-42756	0.3431,482	0.2233,001	-
10-32388-1 Obsolete	F35B-9	09-45167	09-806B-1*	01-42910	01-46794-03	0.2233,005	01-42911	Obsolete	01-46794-10	-	Obsolete	-	-	-
10-32412-1 Obsolete, repl. by 10-35157-3	F35B-9	-	09-806B-1*	01-42415	01-46794-03	0.2233,005	01-42417	Obsolete	01-46794-10	-	Obsolete	-	-	-
10-32412-2 Obsolete, repl. by 10-35157-4	F35B-902	-	09-808B-1*	01-42910	01-46794-03	0.2233,010	01-43240	01-43239	01-46794-10	-	01-45175	01-43131	-	-
10-32415-1 Obsolete, repl. by 10-35157-3	F35B-9	-	09-808B-1*	01-42910	01-46794-03	0.2233,010	01-43240	01-43239	01-46794-10	-	01-45175	01-43131	-	-
10-32579-1	F3P10	-	09-1052S-9*	-	-	-	-	-	-	-	-	-	-	-
10-32588-1 Obsolete	F4B-9	09-45904	09-1026B-1*	01-42389	01-46794-04	0.2233,005	01-42391	01-42388-1	01-46794-03	-	Obsolete	-	-	-
10-32603-1 Obsolete	F5B-9	09-45913	09-801B-1*	01-42397	01-46794-05	0.2233,001	01-42401	01-42398	0.0141,500	-	Obsolete	Obsolete	-	-
10-32621-1 Obsolete, repl. by 10-32621-3	F5B-902	09-45913	09-801B-1*	01-45014	0.0279,032	0.2233,001	01-45930	01-45021	0.0141,901	-	01-45022	01-45023	-	-
10-32621-2	F5B-9	09-45913	09-801B-1*	01-42397	01-46794-05	0.2233,001	01-45930	01-45021	0.0141,901	-	01-45022	01-45023	-	-
10-32621-3	F5B-902	09-45913	09-801B-1*	01-45014	0.0279,032	0.2233,001	01-45930	01-45021	0.0141,901	-	01-45022	01-45023	-	-

A - parts no. 1, 4, 5, 7 included front

** - shaft drive end *** - included in service kit **** - back ***** -

Flexible Impeller Pumps

Part no.	Pump type	Service kit	Impeller	Cam	3	4	5	6	7	8	9	10	11	Clutch or Motor
A			1	2	Camscrew	Seal	Gasket	Endcover	Endcover screw	Wearplate	Shaft	Bearing	Bearing seal	
10-35015-1 Obsolete, repl. by 10-35157- (Customer branded)	F35B-9	09-45589	09-808B-1*	01-42910	01-46794-03	0.2233,010	01-43240	Cust.brand.	0.0279,300	-	01-45175	01-43131	-	-
10-35015-2	F35B-9	09-45589	09-808B-1*	01-42910	01-46794-03	0.2233,010	01-43240	01-43239	0.0279,300	-	01-45175	01-43131	-	-
10-35015-3 Obsolete, repl. by 10-35157-3	F35B-9	09-45589	09-808B-1*	01-42910	01-46794-03	0.2233,010	01-43240	01-43239	0.0279,300	-	01-45175	01-43131	-	-
10-35024-1 Obsolete, repl. by 10-35098-2	F4B-9	09-45904	09-1026B-1*	01-42389	01-46794-04	0.2233,005	01-42391	01-42388-1	01-46794-03	-	Obsolete	-	-	-
10-35038-1	F35B-8	09-45589	09-808B-1*	01-42910	01-46794-03	0.2233,010	01-43240	01-43239	0.0279,300	01-45087	01-45069	0.3431,748	-	-
10-35038-2 Obsolete	F35B-802	09-45589	09-808B-1*	01-42415	01-46794-10	0.2233,010	01-43240	01-43239	0.0279,300	01-45087	01-45069	0.3431,748	-	-
10-35038-3 Obsolete	F35B-8	09-45589	09-808B-1*	01-42910	01-46794-03	0.2233,010	01-43240	01-43239	0.0141,500	01-45087	Obsolete	0.3431,748	-	-
10-35038-4 Obsolete, repl. by 10-35038-41	F35B-8007	09-45589	09-808B-1*	01-42415	01-46794-10	0.2233,010	01-43240	01-43239	0.0141,500	01-45087	01-45069	0.3431,748	-	-
10-35038-5	F35B-8027	09-45589	09-808B-1*	01-42415	01-46794-10	0.2233,010	01-43240	01-43239	0.0141,500	01-45087	01-45069	0.3431,748	-	-
10-35038-6 Obsolete	F35B-802	09-45589	09-808B-1*	01-42415	01-46794-10	0.2233,010	01-43240	01-43239	0.0141,500	01-45087	Obsolete	0.3431,748	-	-
10-35038-7 Obsolete, repl. by 10-35038-9	F35B-8027	09-45589	09-808B-1*	01-42415	01-46794-10	0.2233,010	01-43240	01-43239	0.0141,700	01-45087	01-45069	0.3431,748	-	-
10-35038-8 Obsolete	F35B-8	09-45589	09-808B-1*	01-42910	01-46794-03	0.2233,010	01-43240	01-46675	0.0141,700	01-46676	01-45069	0.3431,748	-	-
10-35038-9 Customer branded	F35B-8007	09-45589	09-808B-1*	01-42910	01-46794-03	0.2233,010	01-43240	01-43239	0.0141,700	01-45087	01-45069-2	0.3431,748	-	-
10-35038-41	F35B-8007	09-45589	09-808B-1*	01-42415	01-46794-10	0.2233,010	01-43240	01-43239	0.0141,500	01-45087	01-46416	0.3431,748	-	-
10-35039-1 Obsolete	F35B-9	-	09-806B-1*	01-42910	01-46794-03	0.2233,010	01-43240	01-43239	0.0279,501	-	Obsolete	01-43131	-	-
10-35052-1 Obsolete	F35B-9	09-45589	09-808B-1*	01-42910	01-46794-03	0.2233,010	01-43240	01-43239	0.0279,501	01-45087	01-45098	0.3431,748	-	-
10-35055-1 Customer branded	F2P10-19 12V	09-45594	09-1077B-9*	-	-	0.2233,402	0.2172,506	21-4945	0.0140,001	21-4944**** 21-4946****	-	-	-	01-35285-01
10-35055-2 Customer branded	F2P10-19 24V	09-45594	09-1077B-9*	-	-	0.2233,402	0.2172,506	21-4945	0.0140,001	21-4944**** 21-4946****	-	-	-	01-35285-02

A - parts no. 1, 4, 5, 7 included front * - gasket included ** - shaft drive end *** - included in service kit **** - back ***** -

Flexible Impeller Pumps

Part no.	Pump type	Service kit	Impeller	Cam	3	4	5	6	7	8	9	10	11
				Cam	Camscrew	Seal	Gasket	Endcover	Endcover screw	Wearplate	Shaft	Bearing	Bearing seal
				2									
			1										
		A											
10-35058-1 Obsolete	F4B-9	09-45904	09-1026B-1*	01-42389	01-46794-04	0.2233.005	01-42391	01-42388-1	0.0279.501	-	Obsolete	-	-
10-35064-1	F4B-9	09-45904	09-1026B-01* 09-1026B-1*	01-42389	01-46794-03	0.2233.005	01-42391	01-42388-1	01-46794-03	-	01-45111	-	-
10-35065- Obsolete, repl. by 10-35157-3 + 10-24143-1	F35B/F35B-9	-	09-808B-1* 09-808B-1*	01-42910 0.2233.200	01-46794-03 01-45400	0.2233.010	01-43240	01-43239	0.0141.500	01-45087	Obsolete	01-43131	-
10-35066- Obsolete, repl. by 10-35157-3 + 10-24143-1	F35B/F35B-9	09-45894	09-808B-1* F35B-9	01-42910	01-46794-03	0.2233.010	01-43240	01-43239	0.0141.500	01-45087	Obsolete	01-43131	-
10-35067-1 Obsolete	F5B-9	09-45913	09-801B-1*	01-42397	01-46794-05	0.2233.001	01-42401	Obsolete	0.0141.500	-	Obsolete	Obsolete	-
10-35087-1 Obsolete	F4B-9	09-45905	09-1026B-1*	01-42389	01-46794-04	0.2233.010	01-42391	01-42388-1	0.0279.501	-	Obsolete	-	-
10-35088-1 Obsolete, repl. by 10-35157-3 (Customer branded)	F35B-9	09-45589	09-808B-1*	01-42910	01-46794-03	0.2233.010	01-43240	01-43239	0.0279.501	-	01-45175	01-43131	-
10-35088-2 Obsolete, repl. by 10-35157-3	F35B-9/02	09-45589	09-808B-1*	01-42415	01-46794-03	0.2233.010	01-43240	01-43239	0.0279.501	-	01-45175	01-43131	-
10-35088-3 Obsolete, repl. by 10-35157-3	F35B-9	09-45589	09-808B-1*	01-42910	01-46794-03	0.2233.010	01-43240	01-43239	0.0279.501	-	01-45175	01-43131	-
10-35091-1 Obsolete	F35B-9	09-45589	09-808B-1*	01-42910	01-46794-03	0.2233.010	01-43240	01-43239	0.0279.501	01-45087	01-45193	0.3431.441	0.2233.010 ***
10-35091-2 Obsolete	F35B-9/02	09-45589	09-808B-1*	01-42415	01-46794-10	0.2233.010	01-43240	01-43239	0.0279.501	01-45087	01-45193	0.3431.441	0.2233.010 ***
10-35091-3 Obsolete	F35B-9/02	09-45589	09-808B-1*	01-42415	01-46794-10	0.2233.010	01-43240	01-43239	0.0279.501	01-45087	01-45193	0.3431.441	0.2233.010 ***
10-35094-1 Obsolete	F4B-9	-	09-1026B-1*	01-42389	01-46794-04	Obsolete	01-42391	01-42388-1	0.0279.501	-	Obsolete	-	-
10-35098-1 Customer branded	F4B-9	09-45905	09-1026B-1*	01-42389	01-46794-03	0.2233.010	01-45284	01-45282	0.0279.501	-	01-45235	0.3431.441	0.2233.010 ***
10-35098-2	F4B-9	09-45905	09-1026B-1*	01-42389	01-46794-03	0.2233.010	01-45284	01-45282	0.0279.501	-	01-45235	0.3431.441	0.2233.010 ***
10-35098-3	F4B-9	09-45905	09-1026B-1*	01-42389	01-46794-03	0.2233.010	01-45284	01-45282	0.0279.501	-	01-45235	0.3431.441	0.2233.010 ***
10-35098-4	F4B-9	09-45905	09-1026B-1*	01-42389	01-46794-03	0.2233.010	01-45284	01-45282	0.0279.501	-	01-45235	0.3431.441	0.2233.010 ***
10-35100-1	F5B-9	09-45585	09-1027B-1*	01-42397	01-46794-05	0.2233.001	01-42401	01-42398	0.0279.500	01-42399	01-45187	0.3431.761	-
10-35115-1 Obsolete, can be replaced by 10-35333-01 + 2 pcs clamp	F4B-9	09-45587	09-810B-1* 01-43238	01-42389	01-46794-03	0.2233.010	01-45284	01-45282	0.0279.501	-	01-45193	0.3431.441 ***	0.2233.010

A - parts no. 1, 4, 5, 7 included * - gasket included ** - shaft drive end *** - included in service kit **** - back ***** - front

Flexible Impeller Pumps

Part no.	Pump type	Service kit	Impeller	Cam	3	4	5	6	7	8	9	10	11	Clutch or Motor
A				2	Camscrew	Seal	Gasket	Endcover	Endcover screw	Wearplate	Shaft	Bearing	Bearing seal	
10-35115-2 Obsolete, can be replaced by 10-35333-01 + 2 pcs clamp 01-43238	F4B-903	09-45587	09-810B-1*	01-45288	01-46794-03	0.2233.010	01-45284	01-45282	0.0279.501	-	01-45193	0.3431.441	0.2233.010	-
10-35118-1	F35B-9	09-45589	09-808B-1*	01-42910	01-46794-03	0.2233.010	01-43240	01-43239	0.0279.501	-	01-45175	-	-	-
10-35118-2	F35B-9	09-45589	09-808B-1*	01-42910	01-46794-03	0.2233.010	01-43240	01-43239	0.0279.501	-	01-45175	-	-	-
10-35122-1 Obsolete, repl. by 10-35211-3	F35B-9	09-45589	09-808B-1*	01-42910	01-46794-03	0.2233.010	01-43240	01-43239	0.0279.501	-	01-45322	-	-	-
10-35124-1	C1AL-3	-	01-35130	-	-	0.2233.010	0.2172.024	01-24150	0.0141.906	-	01-45361	0.3431.748	-	-
10-35124-2 Not in production	C1AL-3	-	01-35130	-	-	0.2233.010	0.2172.024	01-24150	0.0141.906	-	01-45361	0.3431.748	-	-
10-35124-3	C1AL-3	-	01-35130	-	-	0.2233.010	0.2172.024	01-24150	0.0141.906	-	01-45361	0.3431.748	-	-
10-35127-1	F4B-9	09-45587	09-810B-1*	01-42389	01-46794-03	0.2233.010	01-45284	01-45282	0.0279.501	-	01-45353	0.3431.441	0.2233.010	-
10-35127-2 Not in production	F4B-9	09-45587	09-810B-1*	01-42389	01-46794-03	0.2233.010	01-45284	01-45282	0.0279.501	-	01-45353	0.3431.748	0.2233.010	-
10-35127-3	F4B-9	-	09-810B-1*	01-42389	01-46794-03	0.2233.251	01-45284	01-46707	0.0279.501	-	01-46700	0.3431.441	0.2233.010	-
10-35127-4	F4B-9	-	09-810B-1*	01-45288	01-46794-03	0.2233.010	01-45284	01-46707	0.0279.501	-	01-46700	0.3431.441	0.2233.010	-
10-35141-1	F35B-9	-	09-808B-1*	01-42910	01-46794-03	-	01-43240	01-45359	0.0141.500	01-45087	01-45360	01-45110	-	-
10-35141-2	F35B-902	-	09-808B-1*	01-42415	01-46794-10	-	01-43240	01-45359	0.0141.500	01-45087	01-45360	01-45110	-	-
10-35142-1	F4B-9	-	09-810B-1*	01-42389	01-46794-04	-	01-42391	01-42388-2	0.0141.500	-	01-45398	01-45397	-	-
10-35142-2	F4B-903	-	09-810B-1*	01-45288	01-46794-03	-	01-42391	01-42388-2	0.0141.500	-	01-45398	01-45397	-	-
10-35157-1	F35B-9	09-45589	09-808B-1*	01-42910	01-46794-03	0.2233.010	01-43240	01-43239	0.0279.501	01-45087	01-45556	0.3431.441	0.2233.010	-
10-35157-2	F35B-902	09-45589	09-808B-1*	01-42415	01-46794-10	0.2233.010	01-43240	01-43239	0.0279.501	01-45087	01-45556	0.3431.441	0.2233.010	-
10-35157-3	F35B-9	09-45589	09-808B-1*	01-42910	01-46794-03	0.2233.010	01-43240	01-43239	0.0279.501	01-45087	01-45556	0.3431.441	0.2233.010	-
10-35157-4	F35B-902	09-45589	09-808B-1*	01-42415	01-46794-10	0.2233.010	01-43240	01-43239	0.0279.501	01-45087	01-45556	0.3431.441	0.2233.010	-
10-35157-5 Customer branded	F35B-9	09-45589	09-808B-1*	01-42910	01-46794-03	0.2233.010	01-43240	Cust.brand.	0.0279.501	01-45087	01-45556	0.3431.441	0.2233.010	-
10-35157-6	F35B-9	09-45589	09-808B-1*	01-42910	01-46794-03	0.2233.010	01-43240	01-43239	0.0279.501	01-45087	01-45556	0.3431.441	0.2233.010	-

A - parts no. 1, 4, 5, 7 included front * - gasket included ** - shaft drive end *** - included in service kit **** - back ***** -

Flexible Impeller Pumps

Part no.	Pump type	Service kit	Impeller	Cam	3	4	5	6	7	8	9	10	11
		A	1	2	Camscrew	Seal	Gasket	Endcover	Endcover screw	Wearplate	Shaft	Bearing	Bearing seal
10-35157-7 Obsolete	F35B-902	09-45589	09-808B-1*	01-42415	01-46794-10	0.2233.010	01-43240	01-43239	0.0279.501	01-45087	01-45556	0.3431.441	0.2233.010 ***
10-35157-8 Customer branded	F35B-9	09-45589	09-808B-1*	01-42910	01-46794-03	0.2233.010	01-43240	01-43239	0.0279.501	01-45087	01-45556	0.3431.441	0.2233.010 ***
10-35157-9	F35B-9 NPTF	-	09-808B-1*	01-42910	01-46794-03	0.2233.010	01-43240	01-43239	0.0279.501	01-45087	01-45556	0.3431.441	0.2233.010 ***
10-35161-1	F4B-9	09-45587	09-810B-1*	01-42389	01-46794-03	0.2233.010	01-45284	01-45282	0.0279.501	-	01-45832	0.3431.441	0.2233.010 ***
10-35167-1	F4B-9	09-45587	09-810B-1*	01-42389	01-46794-03	0.2233.010	01-45284	01-45282	0.0279.501	-	01-45569	0.3431.441	0.2233.010 ***
10-35167-2 Obsolete	F4B-902	09-45587	09-810B-1*	01-45084	0.0279.501	0.2233.010	01-45284	01-45282	0.0279.501	-	01-45569	0.3431.441	0.2233.010 ***
10-35167-3 Obsolete	F4B-903	09-45587	09-810B-1*	01-45288	01-46794-03	0.2233.010	01-45284	01-45282	0.0279.501	-	01-45569	0.3431.441	0.2233.010 ***
10-35180-1 Obsolete	F5B-8021	09-45585	09-1027B-1*	01-45014	0.0279.032	0.2233.001	01-42401	01-42398	0.0279.500	-	Obsolete	0.3431.742	-
10-35180-2 Obsolete	F5B-8001	09-45585	09-1027B-1*	01-42397	01-46794-05	0.2233.001	01-42401	01-42398	0.0279.500	-	Obsolete	0.3431.742	-
10-35187-1	F35B-9	09-45589	09-808B-1*	01-42910	01-46794-03	0.2233.010	01-43240	01-43239	0.0279.501	01-45087	01-45669	0.3431.441	0.2233.010 ***
10-35187-2	F35B-9	09-45589	09-808B-1*	01-42910	01-46794-03	0.2233.010	01-43240	01-43239	0.0279.501	01-45087	01-45669	0.3431.748	0.2233.010 ***
10-35187-3	F35B-9	09-45589	09-808B-1*	01-42910	01-46794-03	0.2233.010	01-43240	01-43239	0.0279.501	01-45087	01-45669	0.3431.748	0.2233.010 ***
10-35187-4	F35B-9	09-45589	09-808B-01* 09-808B-1*	01-42910	01-46794-03	0.2233.010	01-43240	01-43239	0.0141.700	01-45087	01-45669	0.3431.441	0.2233.010
10-35205-01	F4B-9	-	09-810B-1*	01-42389	01-46794-04	-	01-42391	01-42388-2	01-46794-12	-	01-45709	01-45397	-
10-35205-02	F4B-903	-	09-810B-1*	01-45288	01-46794-03	-	01-42391	01-42388-2	01-46794-12	-	01-45709	01-45397	-
10-35205-1 Obsolete, repl by 10-35205-01	F4B-9	-	-	-	-	-	-	-	-	-	-	-	-
10-35205-2 Obsolete, repl by 10-35205-02	F4B-903	-	-	-	-	-	-	-	-	-	-	-	-
10-35211-1	F35B-9	09-45589	09-808B-1*	01-42910	01-46794-03	0.2233.010	01-43240	01-43239	0.0279.501	01-45087	01-45751	0.3431.441	0.2233.010 ***

A - parts no. 1, 4, 5, 7 included front

* - gasket included

** - shaft drive end

*** - included in service kit

**** - back

***** -

Flexible Impeller Pumps

Part no.	Pump type	Service kit	Impeller	Cam	3	4	5	6	7	8	9	10	11	Clutch or Motor
				Cam	Camscrew	Seal	Gasket	Endcover	Endcover screw	Wearplate	Shaft	Bearing	Bearing seal	
10-35211-2	F35B-902	09-45589	09-808B-1*	01-42415	0.0279.501	0.2233.010	01-43240	01-43239	0.0279.501	01-45087	01-45751	0.3431.441	0.2233.010	-
Not in production														
10-35211-3	F35B-9	09-45589	09-808B-1*	01-42910	01-46794-03	0.2233.010	01-43240	01-43239	0.0279.501	01-45087	01-45353	0.3431.441	0.2233.010	-
10-35211-4	F35B-902	09-45589	09-808B-1*	01-42415	0.0279.501	0.2233.010	01-43240	01-43239	0.0279.501	01-45087	01-45353	0.3431.441	0.2233.010	-
Not in production														
10-35211-5	F35B-9	09-45589	09-808B-1*	01-42910	01-46794-03	0.2233.010	01-43240	01-43239	0.0141.500	01-45087	01-45751	0.3431.748	0.2233.010	-
10-35216-1	F4B-9	09-45905	09-810B-1*	01-42389	01-46794-03	0.2233.010	01-45284	01-45282	0.0141.700	-	01-45762	0.3431.441	0.2233.010	-
Obsolete														
10-35231-1	F5B-9	09-45585	09-1027B-1*	01-42397	01-46794-05	0.2233.001	01-42401	01-42398	0.0279.500	01-42399	01-45187	0.3431.761	-	-
10-35240-1	F4B-9	09-45587	09-810B-1*	01-42389	01-46794-03	0.2233.010	01-45284	01-45282	0.0279.501	-	01-45569	0.3431.441	0.2233.010	-
10-35241-1	F4B-9	09-45587	09-810B-1*	01-42389	01-46794-03	0.2233.010	01-45284	01-45282	0.0279.501	-	01-45556	0.3431.441	0.2233.010	-
10-35241-2	F4B-902	09-45587	09-810B-1*	01-45084	0.0279.501	0.2233.010	01-45284	01-45282	0.0279.501	-	01-45556	0.3431.441	0.2233.010	-
10-35265-1	F4B-9	09-45587	09-810B-1*	01-42389	01-46794-04	-	01-42391	01-42388-2	0.0141.500	-	01-45398	01-45397	-	-
Obsolete														
10-35271-01	F4B-9	09-45587	09-810B-1*	01-42389	01-46794-03	0.2233.010	01-45284	01-45282	0.0279.501	-	01-45950	0.3431.441	0.2233.010	-
10-35288-01	F35B-9	09-45589	09-808B-1*	01-42910	01-46794-03	0.2233.010	01-43240	01-43239	0.0279.501	01-45087	01-45993	0.3431.441	0.2233.010	-
Obsolete														
10-35288-02	F35B-902	09-45589	09-808B-1*	01-42415	01-46794-10	0.2233.010	01-43240	01-43239	0.0279.501	01-45087	01-45993	0.3431.441	0.2233.010	-
Obsolete														
10-35327-01	F5B-9	09-45585	09-1027B-1*	01-42397	01-46794-05	0.2233.001	01-42401	01-42398	0.0279.500	01-42399	01-46085	0.3431.761	-	-
Not in production														
10-35327-02	F5B-902	09-45585	09-1027B-1*	01-45014	0.0279.032	0.2233.001	01-42401	01-42398	0.0279.500	01-42399	01-46085	0.3431.761	-	-
Not in production														
10-35327-03	F5B-903	09-45585	09-1027B-1*	01-45976	01-46794-05	0.2233.001	01-42401	01-42398	0.0279.500	01-42399	01-46085	0.3431.761	-	-

A - parts no. 1, 4, 5, 7 included front * - gasket included ** - shaft drive end *** - included in service kit **** - back ***** -

Flexible Impeller Pumps

Part no.	Pump type	Service kit	Impeller	Cam	3	4	5	6	7	8	9	10	11	Clutch or Motor
A			1	2	Camscrew	Seal	Gasket	Endcover	Endcover screw	Wearplate	Shaft	Bearing	Bearing seal	
10-353333-01	F4B-9	09-45587	09-810B-1*	01-42389	01-46794-03	0.2233,010	01-45284	01-45282	0.0279,501	-	01-45193	0.3431,441	0.2233,010	-
10-353555-01	F4B-9	09-45587	09-810B-1*	01-42389	01-46794-03	0.2233,010	01-45284	01-45282	0.0279,300	-	01-46167	0.3431,441	0.2233,010	-
10-35725-01	F4B-9	09-45587	09-810B-1*	01-42389	01-46794-03	0.2233,010	01-45284	01-45282	0.0141,700	-	01-46460	0.3431,441	0.2233,010	-
10-35731-01	F35B/F35B-9													
10-36006-01 Customer branded	F4B-9	-	09-810B-1*	01-42389	01-46794-03	09-0.2247,021	0.2173,476	01-46007-2	0.0141,700	01-46737-2	01-47065	0.3431,441	-	
10-42864-1 Obsolete	F5B-9	09-45913	09-801B*	01-42397	01-46794-05	0.2233,001	01-42401	Obsolete	01-46794-04	01-42399	Obsolete	-	-	-
20-4941-02 Obsolete	F2P10-220V	09-45594	09-1077B-9*	-	-	0.2233,402/ 0.0357,002	0.2172,506	21-4945	0.0140,001	21-4944 **** 21-4946 *****	-	-	-	Obsolete

A - parts no. 1, 4, 5, 7 included front
 * - gasket included
 ** - shaft drive end
 *** - included in service kit
 **** - back
 ***** -

Water Pressure systems

Water Pressure System Pumps - Aqua Jet WPS 2.4

Part No	Pump Type	A		B		15		14	
		Switch cpl	Switch cpl	Pump kit complete	Fittings x2	Rubberfoot x4	Fitting retainer		
10-24604-01/03	WPS 2.4								
12V ISO228/1-G3/8" 1.7/2.8 bar		09-47028-01	09-47028-01	09-47029	09-46783	09-46780	09-47278		
10-24604-02/04	WPS 2.4								
24V ISO228/1-G3/8" 1.7/2.8 bar		09-47028-01	09-47028-01	09-47029	09-46783	09-46780	09-47278		
10-24604-09/11	WPS 2.4								
12V ISO228/1-G3/8" 1.4/2.1 bar		09-47028-03	09-47028-03	09-47029	09-46783	09-46780	09-47278		
10-24604-10/12	WPS 2.4								
24V ISO228/1-G3/8" 1.4/2.1 bar		09-47028-03	09-47028-03	09-47029	09-46783	09-46780	09-47278		
10-24604-17/19	WPS 2.4								
12V ISO228/1-G3/8" 0.8/1.4 bar		09-47028-04	09-47028-04	09-47029	09-46783	09-46780	09-47278		
10-24604-18/20	WPS 2.4								
24V ISO228/1-G3/8" 0.8/1.4 bar		09-47028-04	09-47028-04	09-47029	09-46783	09-46780	09-47278		
10-24604-101/103	WPS 2.4								
12V 3/8" NPT 1.7/2.8 bar		09-47028-01	09-47028-01	09-47029	09-46957	09-46780	09-47278		
10-24604-102/104	WPS 2.4								
24V 3/8" NPT 1.7/2.8 bar		09-47028-01	09-47028-01	09-47029	09-46957	09-46780	09-47278		

Water Pressure System Pumps - Aqua Jet WPS 2.4

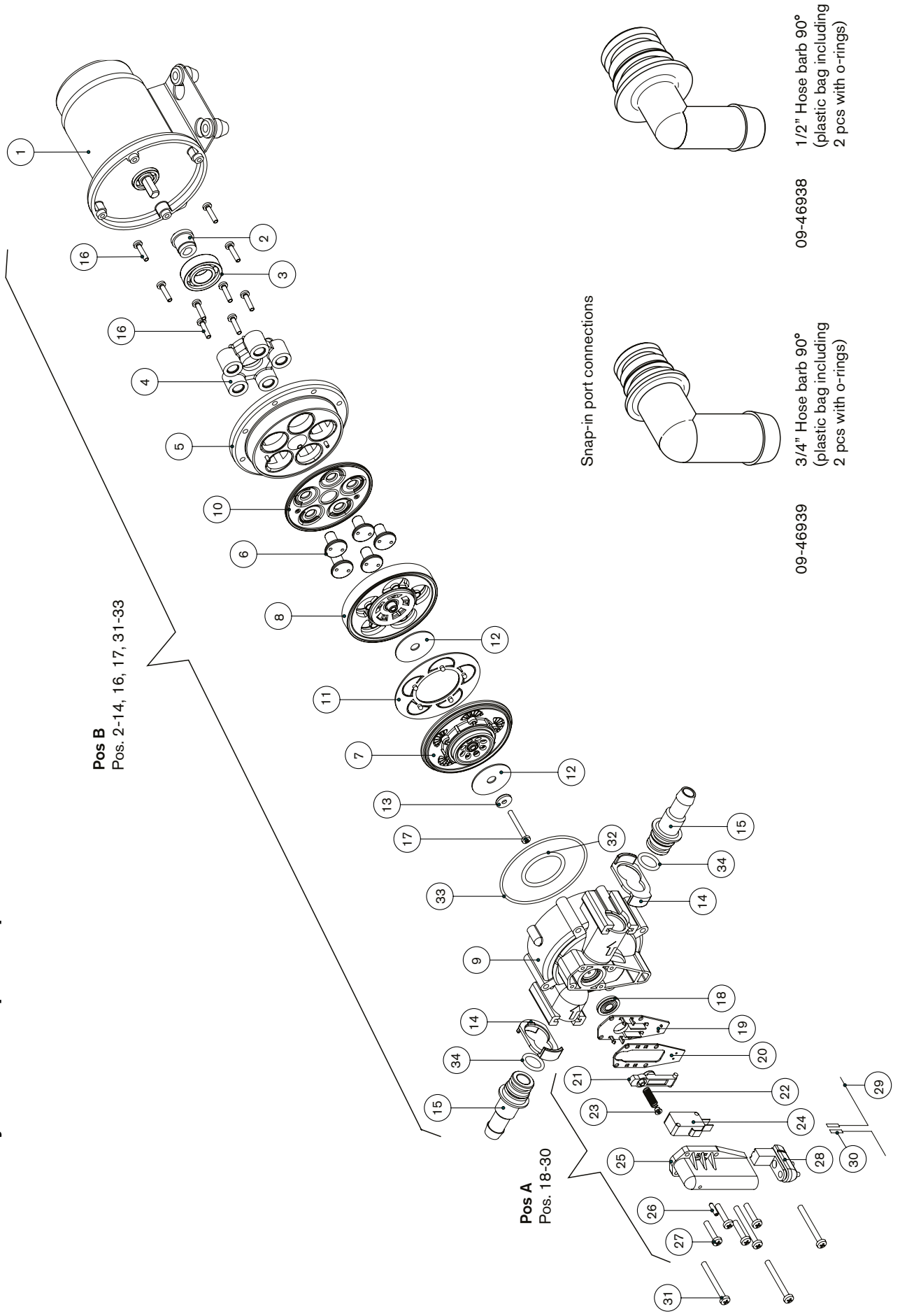

Water Pressure Systems & Wash Down Pumps - Aqua Jet WPS & WD 2.9

Part No	Pump Type	A		B		15		14	
		Switch cpl	Pump kit complete	Fittings 1/2" hose 3/8" BSP	Fittings 1/2" hose 3/8" NPT	Fitting retainer			
10-13405-01/03	WPS 2.9 12V BSP 1.7/2.8 bar	09-47028-01	09-47282	09-46783	-	09-47278			
10-13405-02/04	WPS 2.9 24V BSP 1.7/2.8 bar	09-47028-01	09-47282	09-46783	-	09-47278			
10-13405-09/11	WPS 2.9 12V BSP 1.4/2.1 bar	09-47028-03	09-47282	09-46783	-	09-47278			
10-13405-10/12	WPS 2.9 24V BSP 1.4/2.1 bar	09-47028-03	09-47282	09-46783	-	09-47278			
10-13405-17/19	WPS 2.9 12V BSP 0.8/1.4 bar	09-47028-04	09-47282	09-46783	-	09-47278			
10-13405-18/20	WPS 2.9 24V BSP 0.8/1.4 bar	09-47028-04	09-47282	09-46783	-	09-47278			
10-13405-101/103	WPS 2.9 12V NPT 1.7/2.8 bar	09-47028-01	09-47282	-	09-46957	09-47278			
10-13405-102/104	WPS 2.9 24V NPT 1.7/2.8 bar	09-47028-01	09-47282	-	09-46957	09-47278			
10-24728-03	WD 2.9 12V BSP and NPT 1.7/2.8 bar	09-47028-01	09-47282	09-46783	09-46957	09-47278			
10-24728-04	WD 2.9 24V BSP and NPT 1.7/2.8 bar	09-47028-01	09-47282	09-46783	09-46957	09-47278			

Water Pressure Systems & Wash Down Pumps - Aqua Jet WPS & WD 2.9

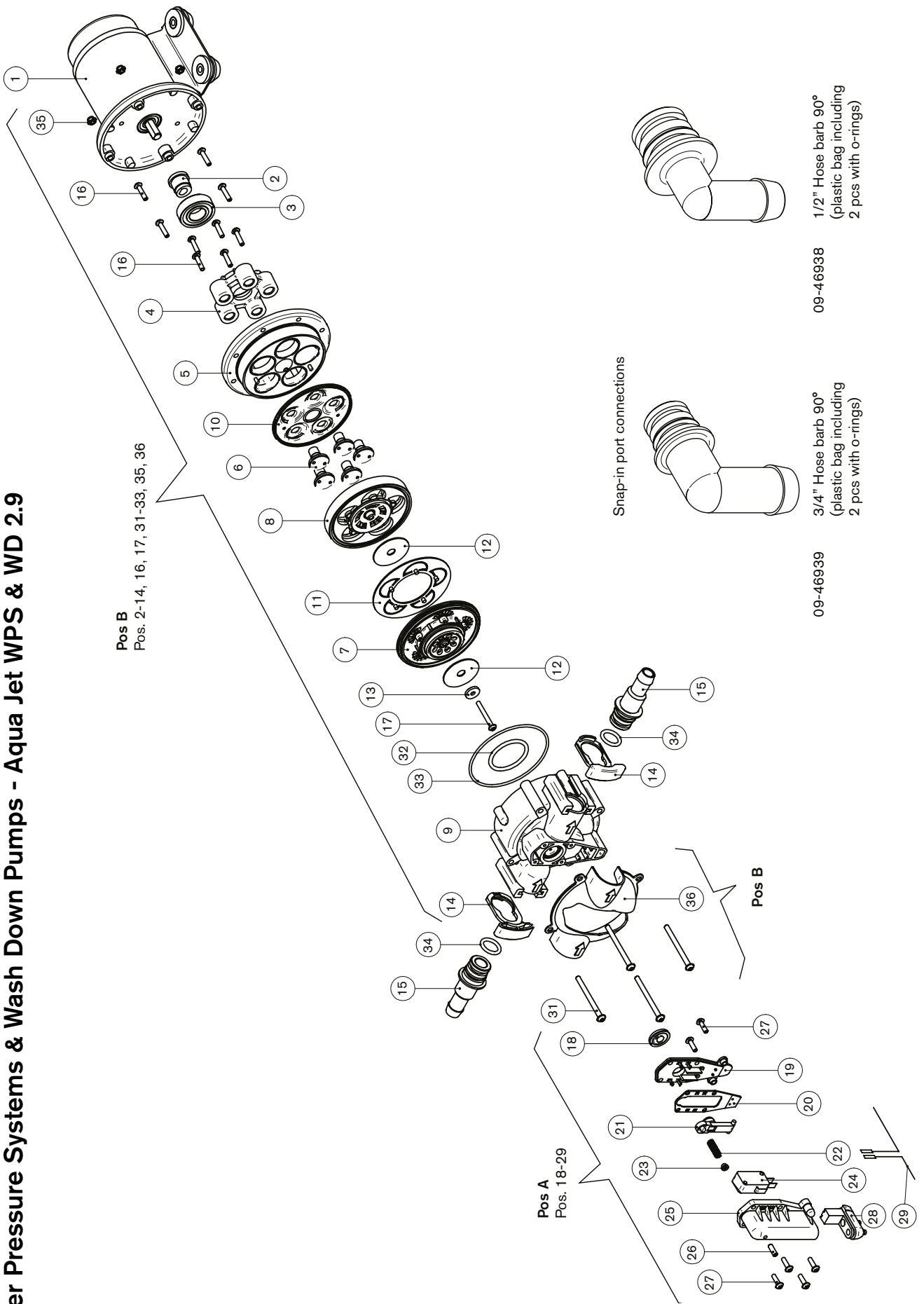

Water Pressure Systems & Wash Down Pumps - Aqua Jet WPS & WD 3.4 & 5.0

Part no.	Pump typ	A Pressure switch cpl	B Diaphragm kit	C Pump head kit	15 Fittings 3/8" hose 1/2" BSP / NPT	15 Fittings 1/2" hose 3/8" BSP / NPT	15 Fittings 3/4" hose 1/2" BSP / NPT	2 Rubber feet	16 Fitting retainer
10-13250-01/03	WPS 3.4-12V BSP	09-46781-01	09-46779-01	09-46782-01	09-46783	09-46784	09-46780	09-47278	
10-13250-02/04	WPS 3.4-24V BSP	09-46781-01	09-46779-01	09-46782-01	09-46783	09-46784	09-46780	09-47278	
10-13250-05/07	WPS 5.0-12V BSP	09-46781-01	09-46779-02	09-46782-02	09-46783	09-46784	09-46780	09-47278	
10-13250-06/08	WPS 5.0-24V BSP	09-46781-01	09-46779-02	09-46782-02	09-46783	09-46784	09-46780	09-47278	
10-13250-09/11	WPS 3.4-12V BSP	09-46781-03	09-46779-01	09-46782-01	09-46783	09-46784	09-46780	09-47278	
10-13250-10/12	WPS 3.4-24V BSP	09-46781-03	09-46779-01	09-46782-01	09-46783	09-46784	09-46780	09-47278	
10-13250-17/19	WPS 3.4-12V BSP	09-46781-04	09-46779-01	09-46782-01	09-46783	09-46784	09-46780	09-47278	
10-13250-18/20	WPS 3.4-24V BSP	09-46781-04	09-46779-01	09-46782-01	09-46783	09-46784	09-46780	09-47278	
10-13250-13/15	WPS 5.0-12V BSP	09-46781-03	09-46779-02	09-46782-02	09-46783	09-46784	09-46780	09-47278	
10-13250-14/16	WPS 5.0-24V BSP	09-46781-03	09-46779-02	09-46782-02	09-46783	09-46784	09-46780	09-47278	
10-13250-21/23	WPS 5.0-12V BSP	09-46781-04	09-46779-02	09-46782-02	09-46783	09-46784	09-46780	09-47278	
10-13250-22/24	WPS 5.0-24V BSP	09-46781-04	09-46779-02	09-46782-02	09-46783	09-46784	09-46780	09-47278	
10-13250-101/103	WPS 3.4-12V NPT	09-46781-01	09-46779-01	09-46782-01	09-46957	09-46958	09-46780	09-47278	
10-13250-102/104	WPS 3.4-24V NPT	09-46781-01	09-46779-01	09-46782-01	09-46957	09-46958	09-46780	09-47278	
10-13250-105/107	WPS 5.0-12V NPT	09-46781-01	09-46779-02	09-46782-02	09-46957	09-46958	09-46780	09-47278	
10-13250-106/108	WPS 5.0-24V NPT	09-46781-01	09-46779-02	09-46782-02	09-46957	09-46958	09-46780	09-47278	
10-13251-01/03	WD 3.4-12V BSP	09-46781-02	09-46779-01	09-46782-03	09-46783	09-46784	09-46780	09-47278	
10-13251-02/04	WD 3.4-24V BSP	09-46781-02	09-46779-01	09-46782-03	09-46783	09-46784	09-46780	09-47278	
10-13251-05/07	WD 5.0-12V BSP	09-46781-02	09-46779-01	09-46782-03	09-46783	09-46784	09-46780	09-47278	
10-13251-06/08	WD 5.0-12V BSP	09-46781-02	09-46779-01	09-46782-03	09-46783	09-46784	09-46780	09-47278	
10-13251-101/103	WD 3.4-12V NPT	09-46781-02	09-46779-01	09-46782-03	09-46957	09-46958	09-46780	09-47278	
10-13251-102/104	WD 3.4-24V NPT	09-46781-02	09-46779-01	09-46782-03	09-46957	09-46958	09-46780	09-47278	
10-13251-105/107	WD 5.0-12V NPT	09-46781-02	09-46779-01	09-46782-03	09-46957	09-46958	09-46780	09-47278	
10-13251-106/108	WD 5.0-24V NPT	09-46781-02	09-46779-01	09-46782-03	09-46957	09-46958	09-46780	09-47278	

Water Pressure Systems & Wash Down Pumps - Aqua Jet WPS & WD 3.4 & 5.0

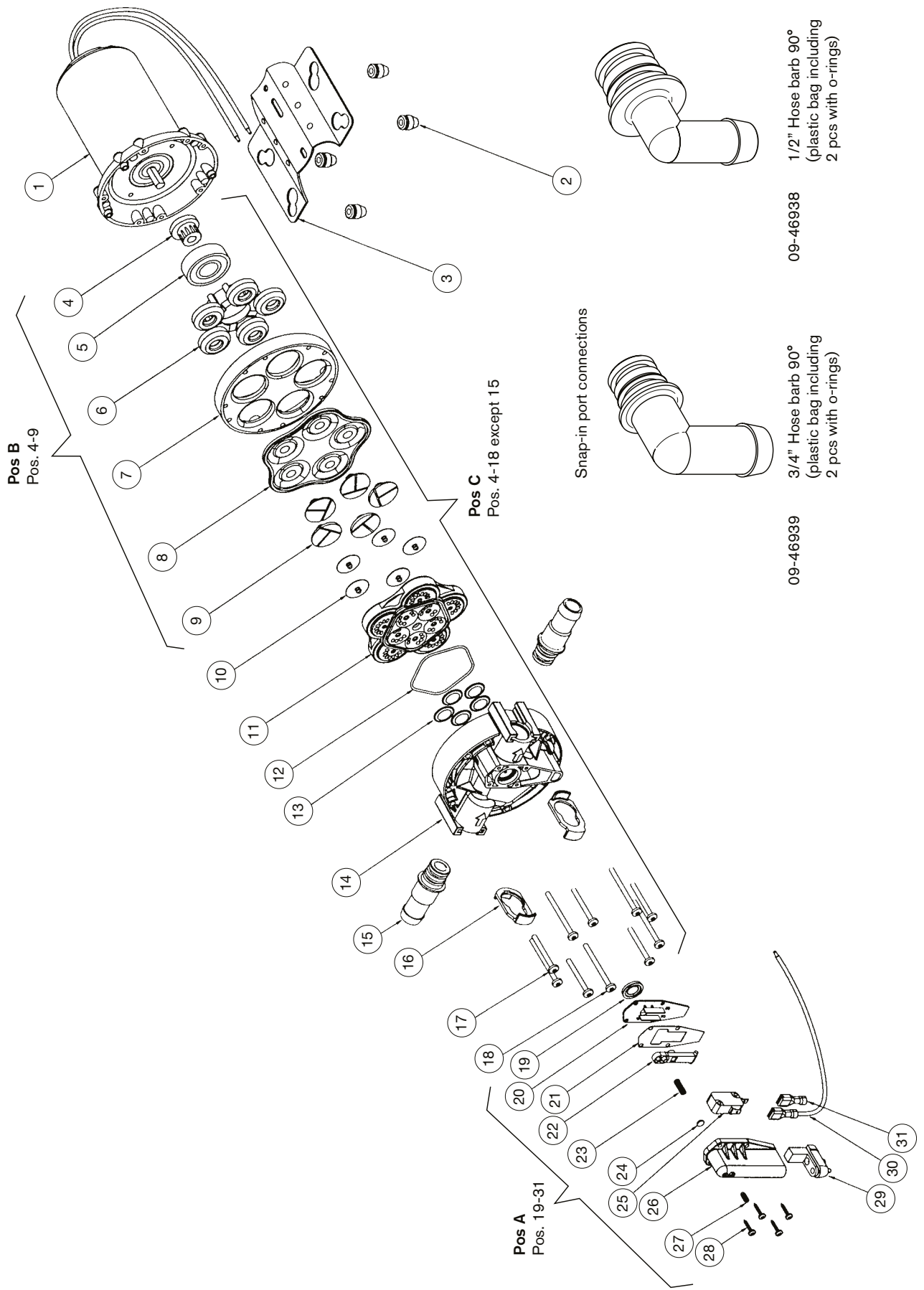

Pos B
Pos. 4-9

Pos C
Pos. 4-18 except 15

Pos A
Pos. 19-31

Snap-in port connections

1/2" Hose barb 90°
(plastic bag including
2 pcs with o-rings)

09-46938

3/4" Hose barb 90°
(plastic bag including
2 pcs with o-rings)

09-46939

Water Pressure System Pumps - Aqua Jet WPS 3.5

Part No	Pump Type	A		B		15		14	
		Switch cpl	Pump kit complete	Fittings 1/2" hose 3/8" BSP	Fittings 1/2" hose 3/8" NPT	Fitting retainer			
10-13395-01/03	WPS 3.5 12V BSP 1.7/2.8 bar	09-47277-01	09-47283	09-46783	-	09-47278			
10-13395-02/04	WPS 3.5 24V BSP 1.7/2.8 bar	09-47277-01	09-47283	09-46783	-	09-47278			
10-13395-05/07	WPS 3.5 12V BSP 1.4/2.1 bar	09-47277-03	09-47283	09-46783	-	09-47278			
10-13395-06/08	WPS 3.5 24V BSP 1.4/2.1 bar	09-47277-03	09-47283	09-46783	-	09-47278			
10-13395-09/11	WPS 3.5 12V BSP 0.8/1.4 bar	09-47277-04	09-47283	09-46783	-	09-47278			
10-13395-10/12	WPS 3.5 24V BSP 0.8/1.4 bar	09-47277-04	09-47283	09-46783	-	09-47278			
10-13395-101/103	WPS 3.5 12V NPT 1.7/2.8 bar	09-47277-01	09-47283	-	09-46957	09-47278			
10-13395-102/104	WPS 3.5 24V NPT 1.7/2.8 bar	09-47277-01	09-47283	-	09-46957	09-47278			

Water Pressure System Pumps - Aqua Jet WPS 3.5

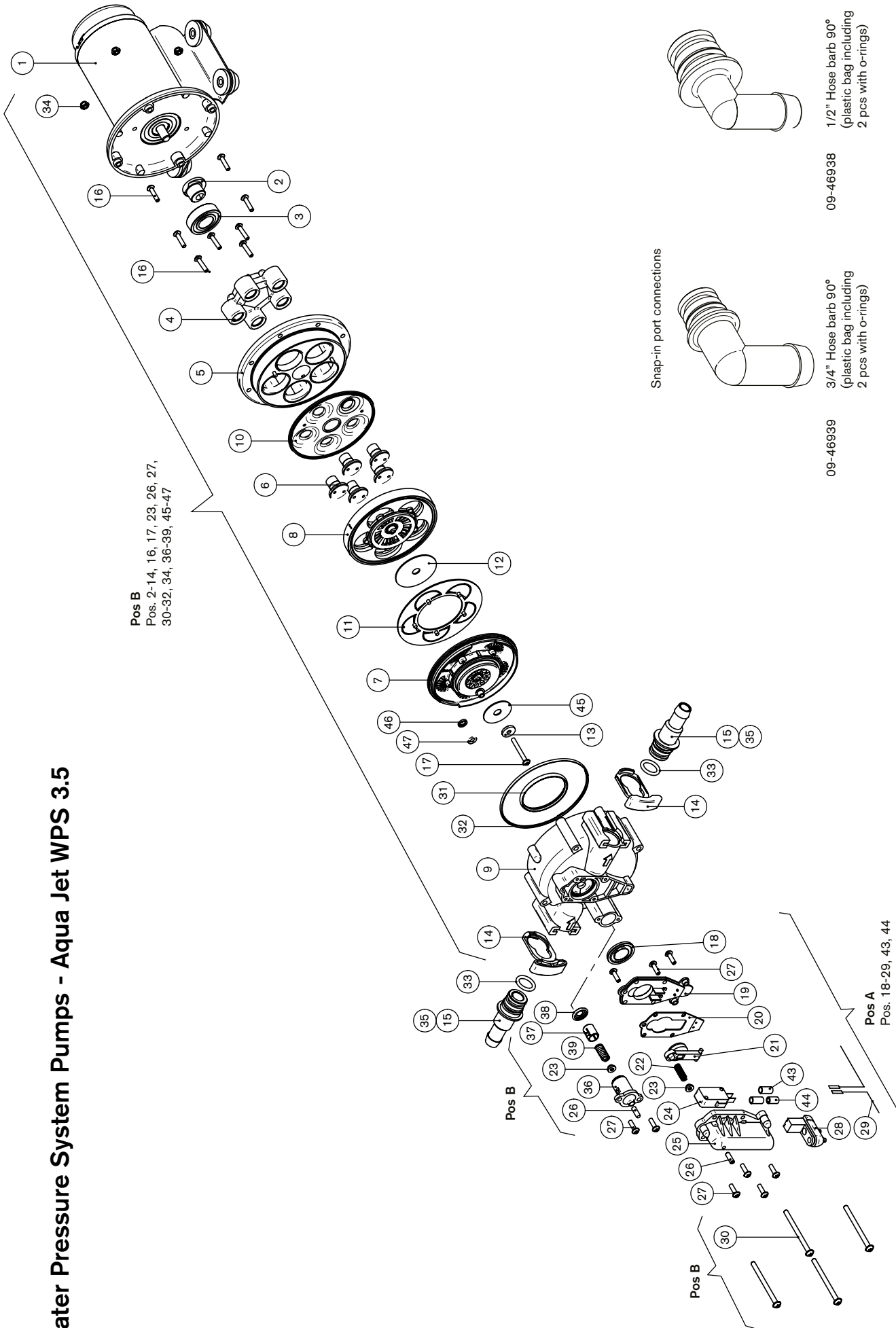

Pos B
Pos. 2-14, 16, 17, 23, 26, 27,
30-32, 34, 36-39, 45-47

Pos A
Pos. 18-29, 43, 44

Snap-in port connections

1/2" Hose barb 90°
(plastic bag including
2 pcs with o-rings)

09-46938

3/4" Hose barb 90°
(plastic bag including
2 pcs with o-rings)

09-46939

Wash Down Pumps - Aqua Jet WD 3.5

Part No	Pump Type	A	B	15	15	14
		Switch cpl	Pump kit complete	Fittings 1/2" hose 3/8" BSP	Fittings 1/2" hose 3/8" NPT	Fitting retainer
10-13399-03	WD 3.5 12V BSP and NPT 3.7/5 bar	09-47277-02	09-47285	09-46783	09-46957	09-47278
10-13399-04	WD 3.5 24V BSP and NPT 3.7/5 bar	09-47277-02	09-47285	09-46783	09-46957	09-47278

Wash Down Pumps - Aqua Jet WD 3.5

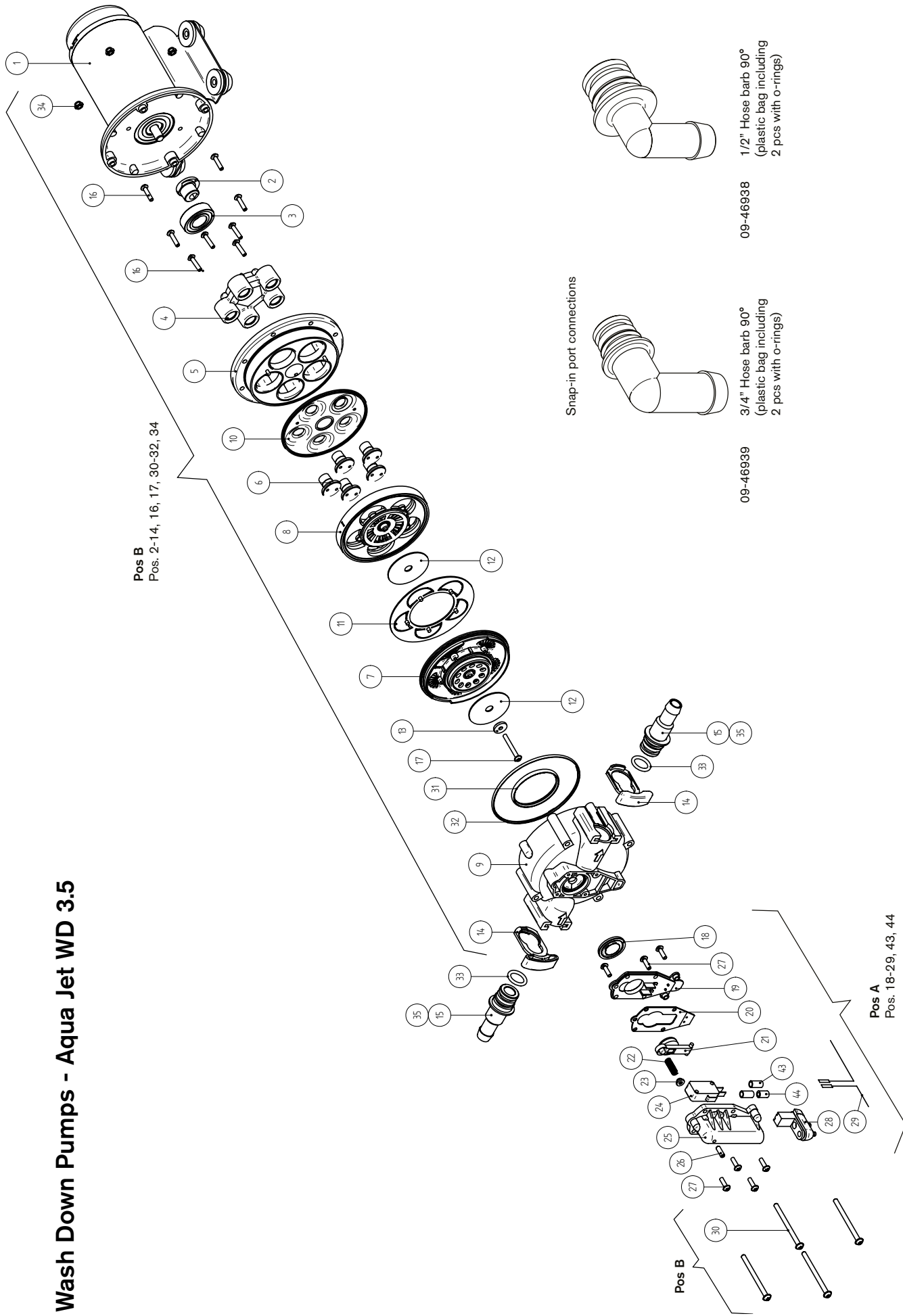

Water Pressure Systems & Wash Down Pumps - Aqua Jet WPS 4.0 & 5.2, WD 5.2

Part No	Pump Type	A	B	15		16	
				Switch cpl	Pump kit complete	Fittings 1/2" hose 3/8" BSP	Fittings 1/2" hose 3/8" NPT
10-13406-01/03	WPS 4.0 12V BSP, 1.7/2.8 bar	09-46781-01	09-47284-01	09-46783	-	09-47278	09-47278
10-13406-02/04	WPS 4.0 24V BSP, 1.7/2.8 bar	09-46781-01	09-47284-01	09-46783	-	09-47278	09-47278
10-13406-05/07	WPS 5.2 12V BSP, 1.7/2.8 bar	09-46781-01	09-47284-02	09-46783	-	09-47278	09-47278
10-13406-06/08	WPS 5.2 24V BSP, 1.7/2.8 bar	09-46781-01	09-47284-02	09-46783	-	09-47278	09-47278
10-13406-09/11	WPS 4.0 12V BSP, 1.4/2.1 bar	09-46781-03	09-47284-01	09-46783	-	09-47278	09-47278
10-13406-10/12	WPS 4.0 24V BSP, 1.4/2.1 bar	09-46781-03	09-47284-01	09-46783	-	09-47278	09-47278
10-13406-13/15	WPS 5.2 12V BSP, 1.4/2.1 bar	09-46781-03	09-47284-02	09-46783	-	09-47278	09-47278
10-13406-14/16	WPS 5.2 24V BSP, 1.4/2.1 bar	09-46781-03	09-47284-02	09-46783	-	09-47278	09-47278
10-13406-17/19	WPS 4.0 12V BSP, 0.8/1.4 bar	09-46781-04	09-47284-01	09-46783	-	09-47278	09-47278
10-13406-18/20	WPS 4.0 24V BSP, 0.8/1.4 bar	09-46781-04	09-47284-01	09-46783	-	09-47278	09-47278
10-13406-21/23	WPS 5.2 12V BSP, 0.8/1.4 bar	09-46781-04	09-47284-02	09-46783	-	09-47278	09-47278
10-13406-22/24	WPS 5.2 24V BSP, 0.8/1.4 bar	09-46781-04	09-47284-02	09-46783	-	09-47278	09-47278
10-13406-101/103	WPS 4.0 12V NPT, 1.7/2.8 bar	09-46781-01	09-47284-01	-	09-46957	09-47278	09-47278
10-13406-102/104	WPS 4.0 24V NPT, 1.7/2.8 bar	09-46781-01	09-47284-01	-	09-46957	09-47278	09-47278
10-13406-105/107	WPS 5.2 12V NPT, 1.7/2.8 bar	09-46781-01	09-47284-02	-	09-46957	09-47278	09-47278
10-13406-106/108	WPS 5.2 24V NPT, 1.7/2.8 bar	09-46781-01	09-47284-02	-	09-46957	09-47278	09-47278
10-13407-07	WD 5.2 12V BSP and NPT, 3.7/5 bar	09-46781-02	09-47286	09-46783	09-46957	09-47278	09-47278
10-13407-08	WD 5.2 24V BSP and NPT, 3.7/5 bar	09-46781-02	09-47286	09-46783	09-46957	09-47278	09-47278

Water Pressure Systems & Wash Down Pumps - Aqua Jet WPS 4.0 & 5.2, WD 5.2

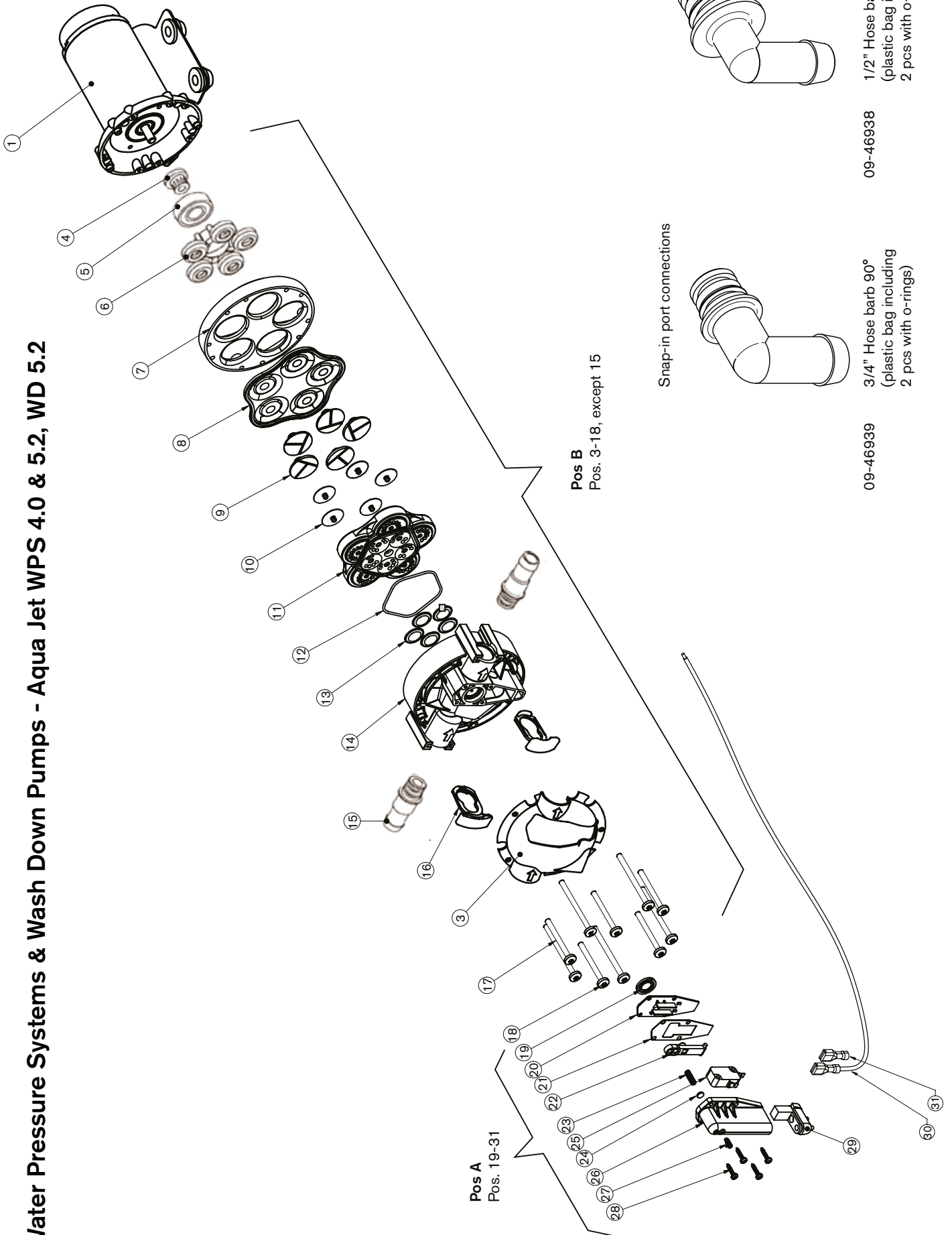

Pos A
Pos. 19-31

Pos B
Pos. 3-18, except 15

Snap-in port connections

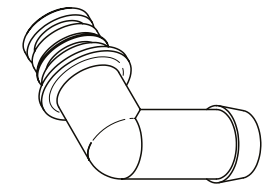

09-46939
3/4" Hose barb 90°
(plastic bag including
2 pcs with o-rings)

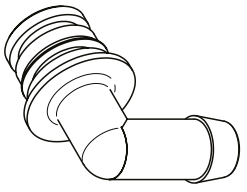

09-46938
1/2" Hose barb 90°
(plastic bag including
2 pcs with o-rings)

Water Pressure System Pumps - Aqua Jet Uno WPS 3.4 & 5.0 incl. accumulator tank

Part no.	Pump typ	A Pressure switch cpl	B Diaphragm kit	C Pump head kit	15 Fittings 3/4" hose barb 90	2 Rubber feet	35 Rubber feet	33 Acc.tank	32 Filter	34 Rubber below Acc.tank
10-13281-01	WPS 3.4 Uno-12V	09-46781-01	09-46779-01	09-46782-01	09-46939	09-46780	09-46908	09-46839-02	48-80036	0.2770.241
10-13281-02	WPS 3.4 Uno-24V	09-46781-01	09-46779-01	09-46782-01	09-46939	09-46780	09-46908	09-46839-02	48-80036	0.2770.241
10-13281-03	WPS 5.0 Uno-12V	09-46781-01	09-46779-02	09-46782-02	09-46939	09-46780	09-46908	09-46839-02	48-80036	0.2770.241
10-13281-04	WPS 5.0 Uno-24V	09-46781-01	09-46779-02	09-46782-02	09-46939	09-46780	09-46908	09-46839-02	48-80036	0.2770.241
10-13281-05	WPS 3.4 Uno-12V	09-46781-01	09-46779-01	09-46782-01	09-46939	09-46780	09-46908	09-46839-01	48-80035	0.2770.241
10-13281-06	WPS 3.4 Uno-24V	09-46781-01	09-46779-01	09-46782-01	09-46939	09-46780	09-46908	09-46839-01	48-80035	0.2770.241
36, 37, 38		Fittings 3/4" hose	09-46944							
37, 38		Fittings 3/4" BSP	09-46945							
36, 37, 38		Fittings 1/2" hose	09-47048							

Water Pressure System Pumps - Aqua Jet Uno WPS 3.4 & 5.0 incl. accumulator tank

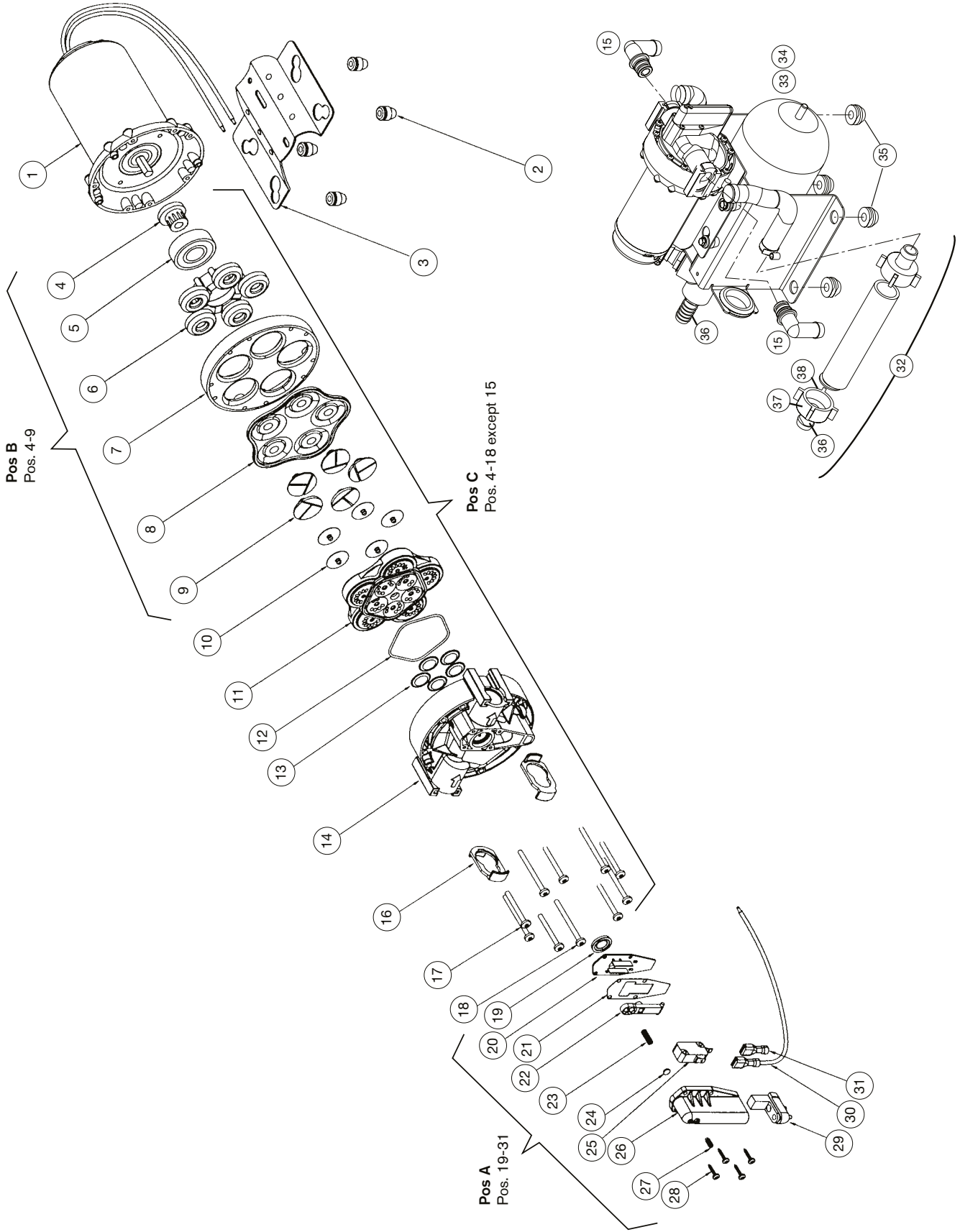

Water Pressure System Pumps - Aqua Jet Uno WPS 3.5 incl. accumulator tank

Part no.	Pump typ	A Pressure switch cpl	B Pump kit complete	15 Fittings 3/4" hose barb 90°	51 Filter, BSP	51 Filter, NPT	52 Acc.tank	34 Rubber below acc.tank	50 Rubber feet	14 Fitting retainer
10-13408-01	WPS 3.5 Uno-12V	09-47277-01	09-47283	09-46939	09-24653-01	09-24653-02	09-46839-02	0.2770.241	09-46908	09-47278
10-13408-02	WPS 3.5 Uno-24V	09-47277-01	09-47283	09-46939	09-24653-01	09-24653-02	09-46839-02	0.2770.241	09-46908	09-47278
10-13408-05	WPS 3.5 Uno-12V	09-47277-01	09-47283	09-46939	09-24653-01	09-24653-02	09-46839-01	0.2770.241	09-46908	09-47278
10-13408-06	WPS 3.5 Uno-24V	09-47277-01	09-47283	09-46939	09-24653-01	09-24653-02	09-46839-01	0.2770.241	09-46908	09-47278
37		Fittings 3/4" hose	09-47414							
37		Fittings 1/2" hose	09-47415							

Water Pressure System Pumps - Aqua Jet Uno WPS 3.5 incl. accumulator tank

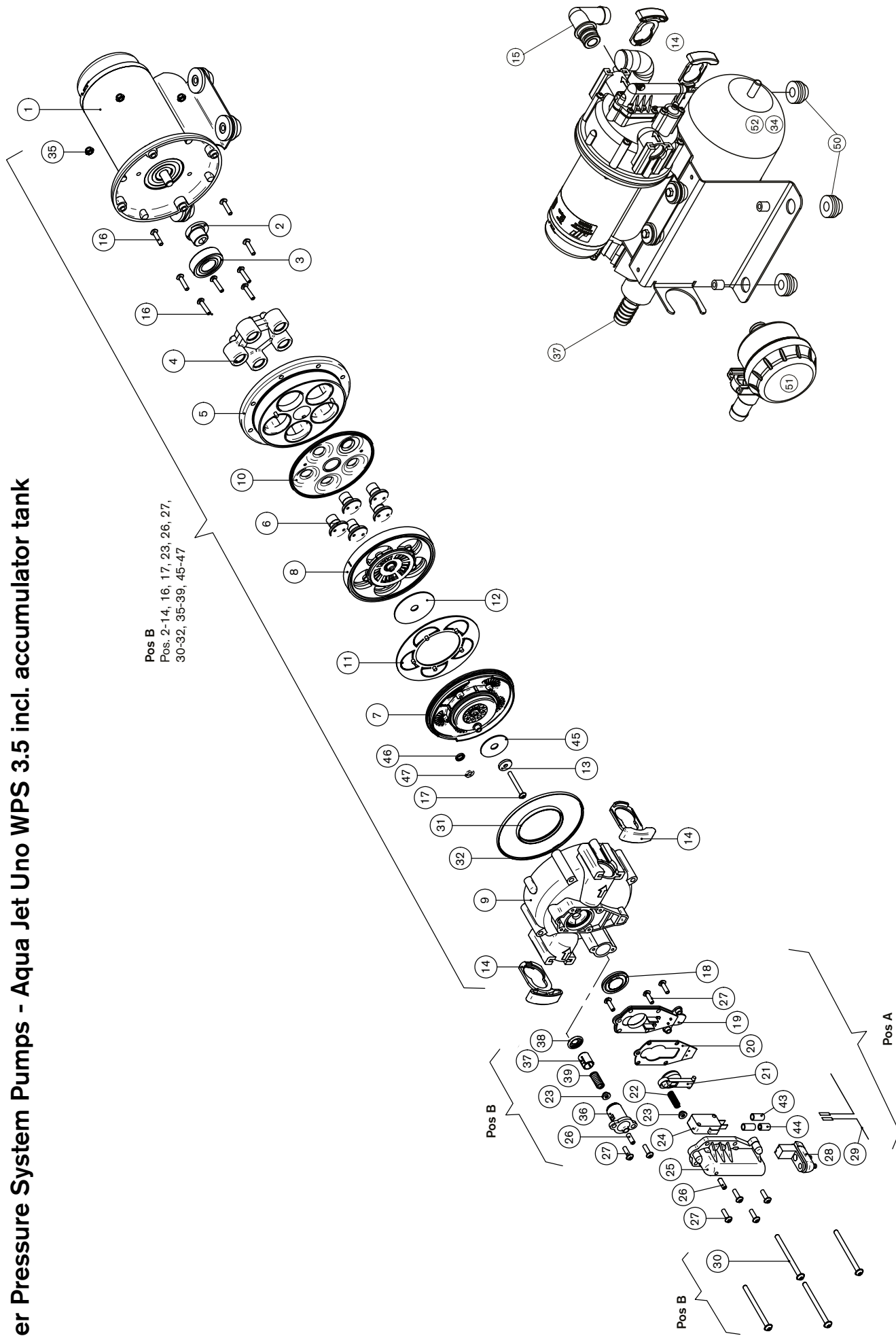

Pos B
 Pos. 2-14, 16, 17, 23, 26, 27,
 30-32, 35-39, 45-47

Pos A
 Pos. 18-29, 43, 44

Water Pressure System Pumps - Aqua Jet Uno WPS 5.2 incl. accumulator tank

Part no.	Pump typ	A	B	15	51	51	52	34	50	16
		Pressure switch cpl	Pump kit complete	Fittings 3/4" hose barb 90°	Filter, BSP	Filter, NPT	Acc.tank	Rubber below acc.tank	Rubber feet	Fitting retainer
10-13408-03	WPS 5.2 Uno-12V	09-46781-01	09-47284-02	09-46939	09-24653-01	09-24653-02	09-46839-02	0.2770.241	09-46908	09-47278
10-13408-04	WPS 5.2 Uno-24V	09-46781-01	09-47284-02	09-46939	09-24653-01	09-24653-02	09-46839-02	0.2770.241	09-46908	09-47278
	37	Fittings 3/4" hose	09-47414							
	37	Fittings 1/2" hose	09-47415							

Water Pressure System Pumps - Aqua Jet Uno WPS 5.2 incl. accumulator tank

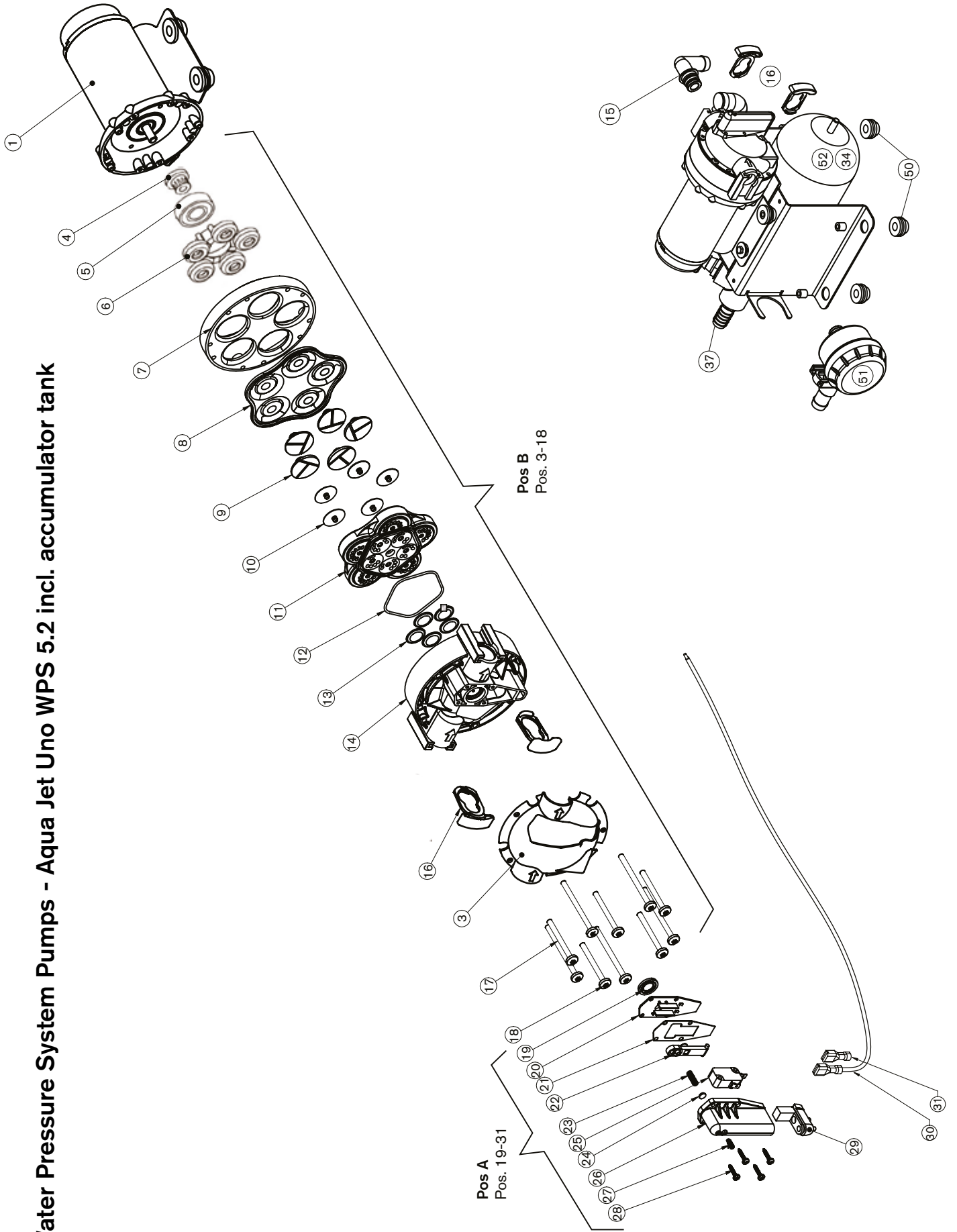

Water Pressure System Pumps - Aqua Jet Uno Max WPS 2.9 incl. accumulator tank

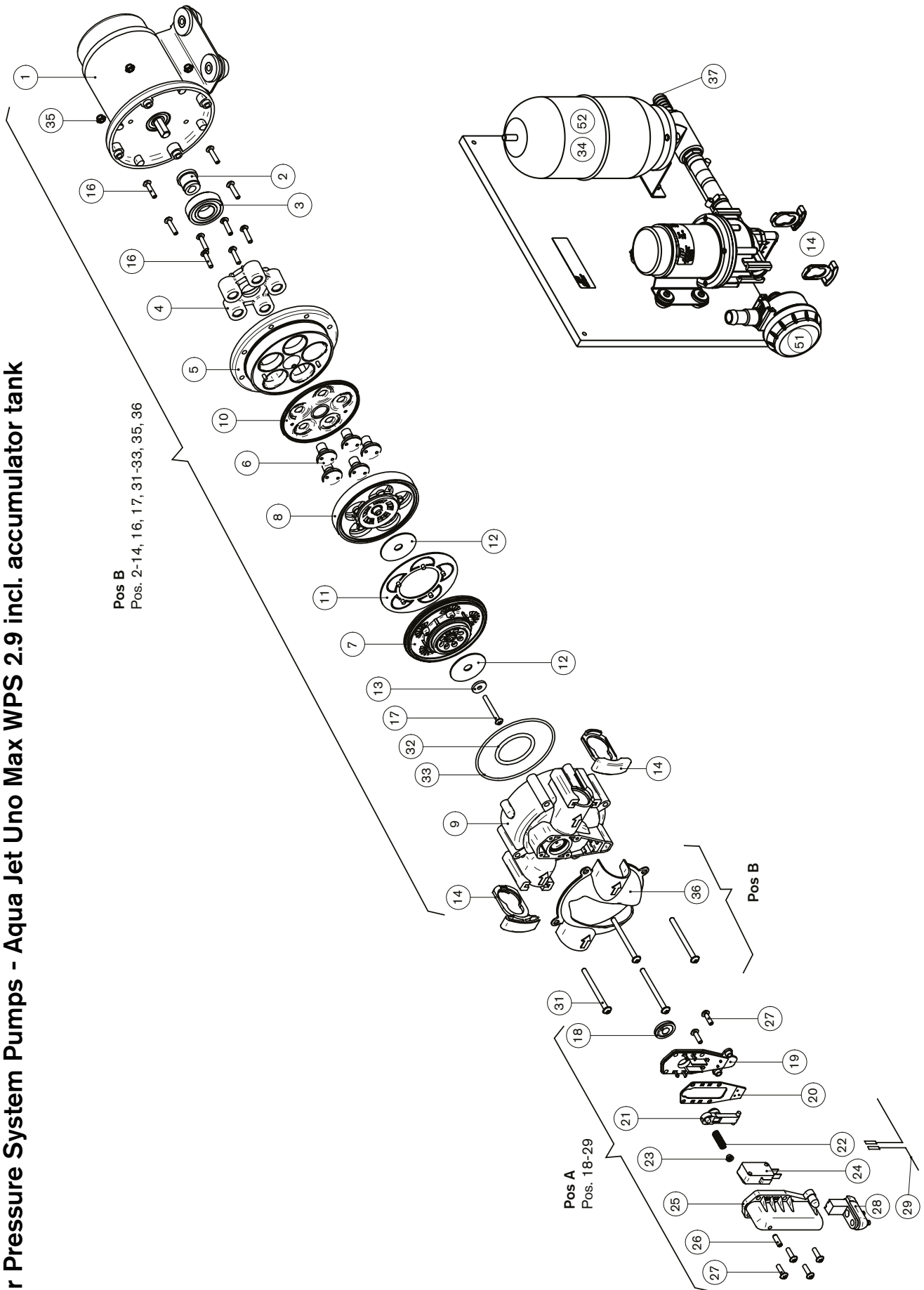

Water Pressure System Pumps - Aqua Jet Uno Max WPS 3.5 incl. accumulator tank

Part no.	Pump typ	A Pressure switch cpl	B Pump kit complete	51 Filter, BSP	51 Filter, NPT	52 Acc.tank	34 Rubber below acc.tank	14 Fitting retainer
10-13411-01	WPS 3.5 Uno-Max 12V 1.7/2.8 bar	09-47277-01	09-47283	09-24653-01	09-24653-02	09-46839-02	0.2770.241	09-47278
10-13411-02	WPS 3.5 Uno-Max 24V 1.7/2.8 bar	09-47277-01	09-47283	09-24653-01	09-24653-02	09-46839-02	0.2770.241	09-47278
10-13411-03	WPS 3.5 Uno-Max 12V 1.4/2.1 bar	09-47277-03	09-47283	09-24653-01	09-24653-02	09-46839-02	0.2770.241	09-47278
10-13411-04	WPS 3.5 Uno-Max 24V 1.4/2.1 bar	09-47277-03	09-47283	09-24653-01	09-24653-02	09-46839-02	0.2770.241	09-47278
			37 Fittings 3/4" hose	09-47414				
			37 Fittings 1/2" hose	09-47415				

Water Pressure System Pumps - Aqua Jet Uno Max WPS 3.5 incl. accumulator tank

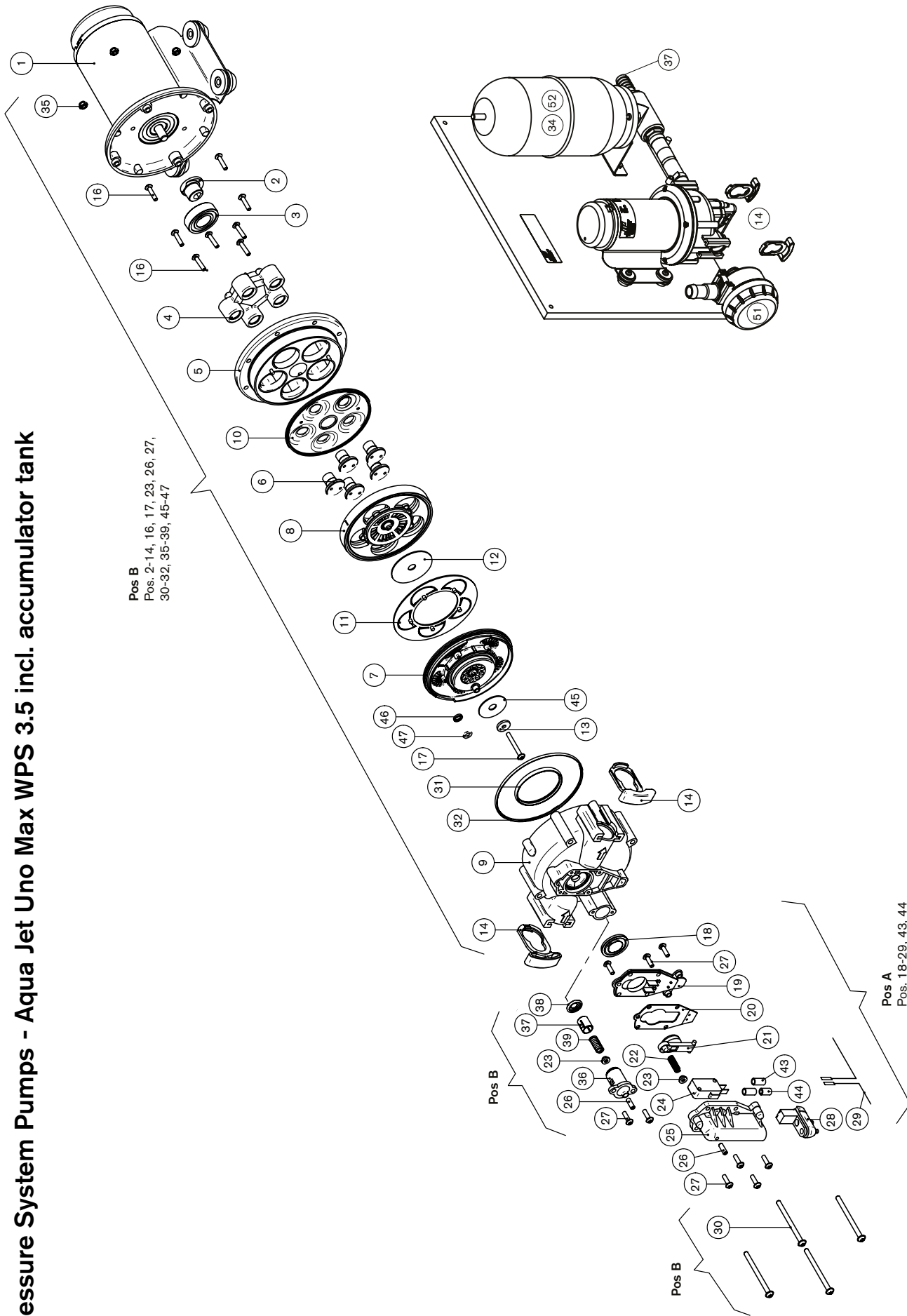

Water Pressure System Pumps - Aqua Jet Duo WPS 10.0 incl. accumulator tank

Part no.	Pump typ	A		B		C		2	35	34	33
		Pump 1	pump 2	Pressure switch cpl pump 1	Pressure switch cpl pump 2	Diaphragm kit	Pump head kit				
10-13273-01	WPS 10.0 Duo-12V	10-13250-07	10-13250-15	09-46781-01	09-46781-03	09-46779-02	09-46782-02	09-46780	09-46908	09-46907	09-46839-02
10-13273-02	WPS 10.0 Duo-24V	10-13250-08	10-13250-16	09-46781-01	09-46781-03	09-46779-02	09-46782-02	09-46780	09-46908	09-46907	09-46839-02

Part no.	Pump typ	37		38		32		36	
		Fittings 3/4 hose	Fittings 3/4 BSP	Fittings 3/4 BSP	Filter	Rubber below	Acc.tank		
10-13273-01	WPS 10.0 Duo-12V	09-46944	09-46945	48-80036	0.2770.241				
10-13273-02	WPS 10.0 Duo-24V	09-46944	09-46945	48-80036	0.2770.241				

Water Pressure System Pumps - Aqua Jet Duo WPS 10.0 incl. accumulator tank

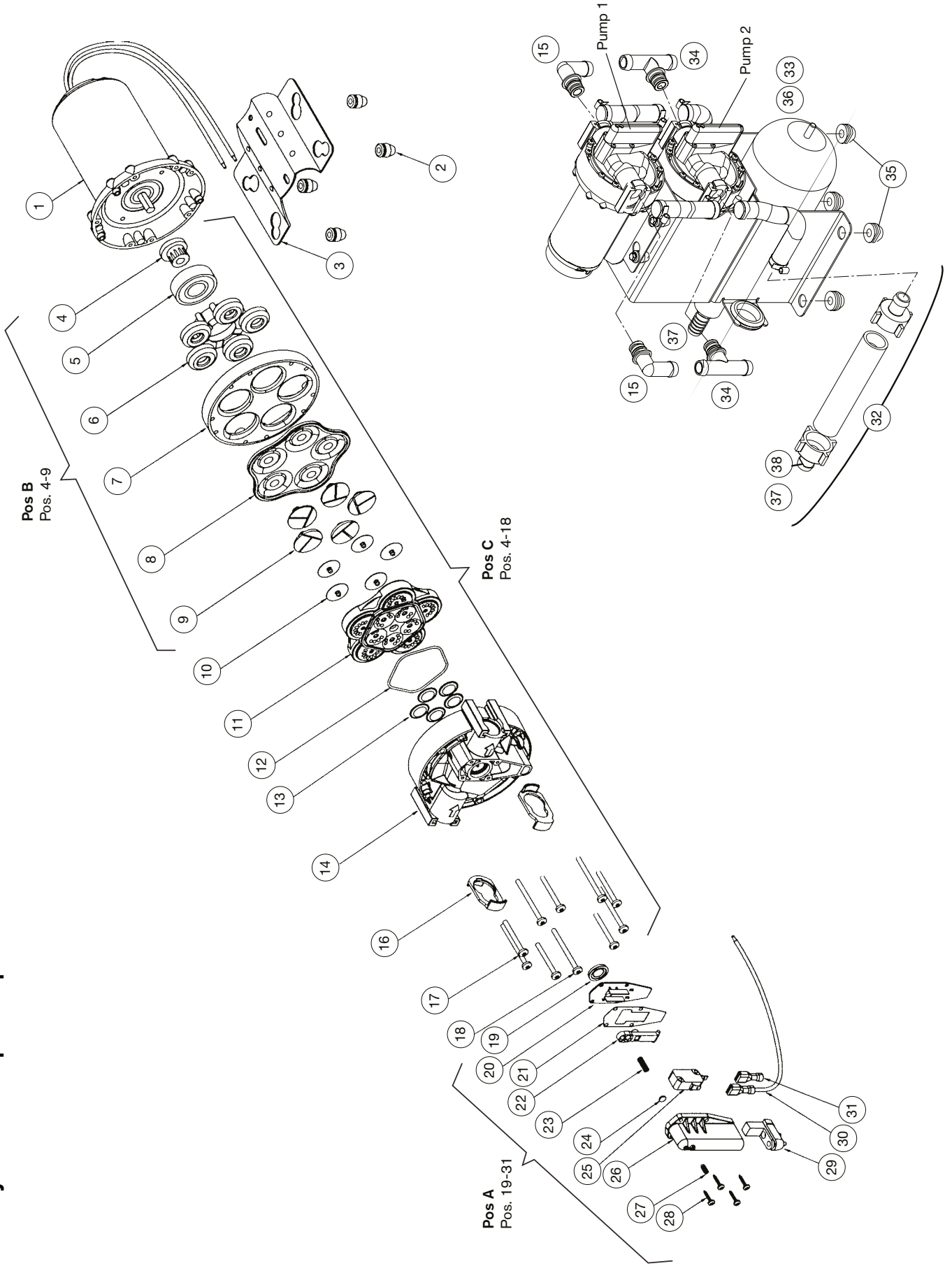

Water Pressure System Pumps - Aqua Jet Duo WPS 10.4 incl. accumulator tank

Part no.	Pump typ	Pump 1		Pump 2		A		B		34	32	32
		Pump 1	Pressure switch cpl	Acc.tank	Pressure switch cpl	Pump head kit	Fittings 3/4" hose barb 90°	T-Fittings	Filter BSP			
10-13409-01	WPS 10.4 Duo-12V	10-13406-07	10-13406-15	09-46781-01	09-46781-03	09-47284-02	09-46939	09-46907	09-24653-01	09-24653-02		
10-13409-02	WPS 10.4 Duo-24V	10-13406-08	10-13406-16	09-46781-01	09-46781-03	09-47284-02	09-46939	09-46907	09-24653-01	09-24653-02		

Part no.	Pump typ	33		36		2		16	
		Acc.tank	Rubber below	Acc.tank	Rubber below	Rubber feet	Fitting	retainer	
10-13409-01	WPS 10.4 Duo-12V	09-46839-02	0.2770.241	0.2770.241	09-46908	09-47278			
10-13409-02	WPS 10.4 Duo-24V	09-46839-02	0.2770.241	0.2770.241	09-46908	09-47278			

- 37 Fittings 3/4" hose 09-47414
- 37 Fittings 1/2" hose 09-47415

Water Pressure System Pumps - Aqua Jet Duo WPS 10.4 incl. accumulator tank

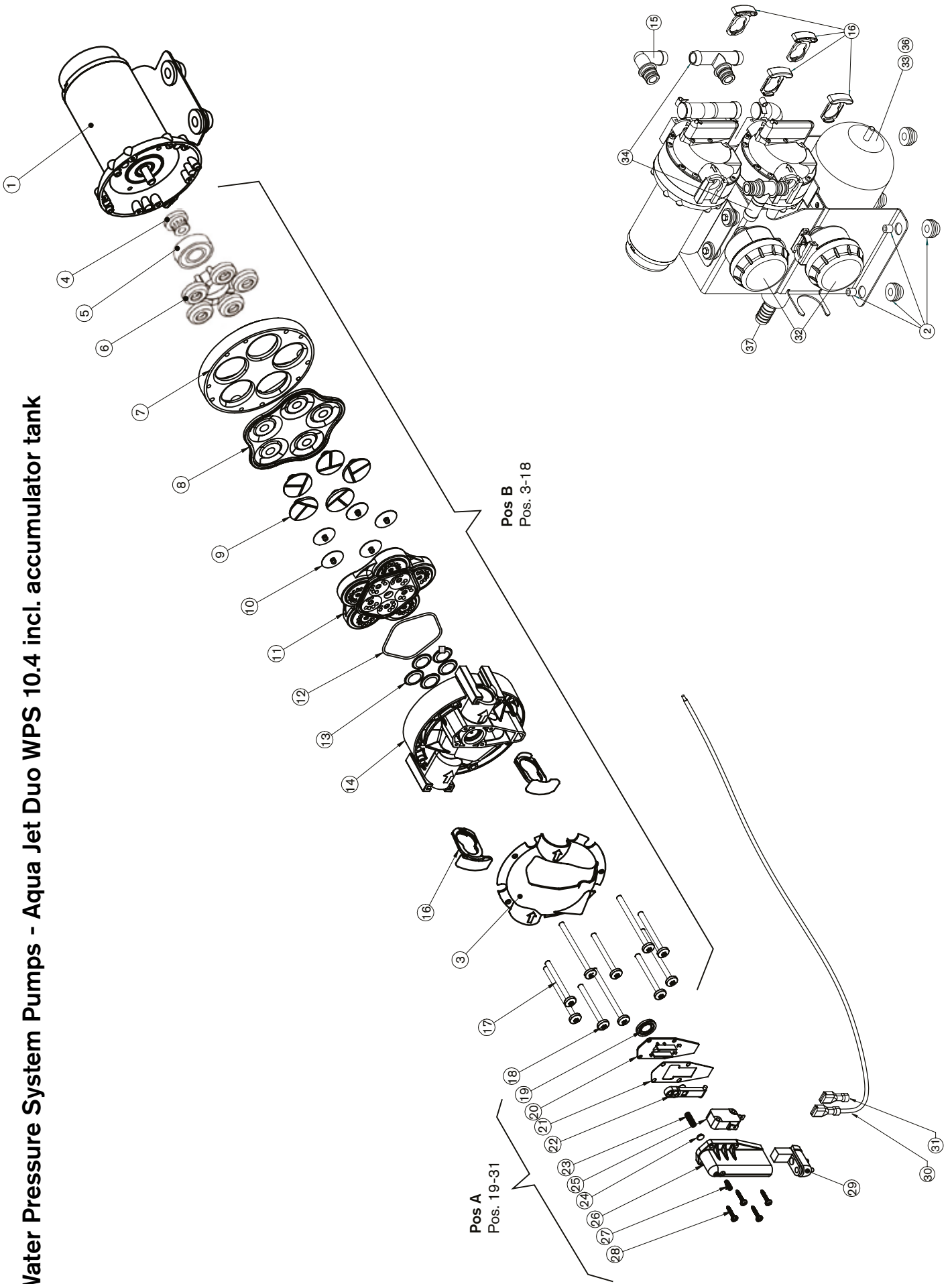

Waste Water Handling & Marine Toilets

Viking Power 16

Part no.	Pump type	Body cpl	Clamp kit	Diaphragm
10-13350-01/03	Viking Power 16 12V	09-47149	09-47263	09-47148
10-13350-02/04	Viking Power 16 24V	09-47149	09-47263	09-47148

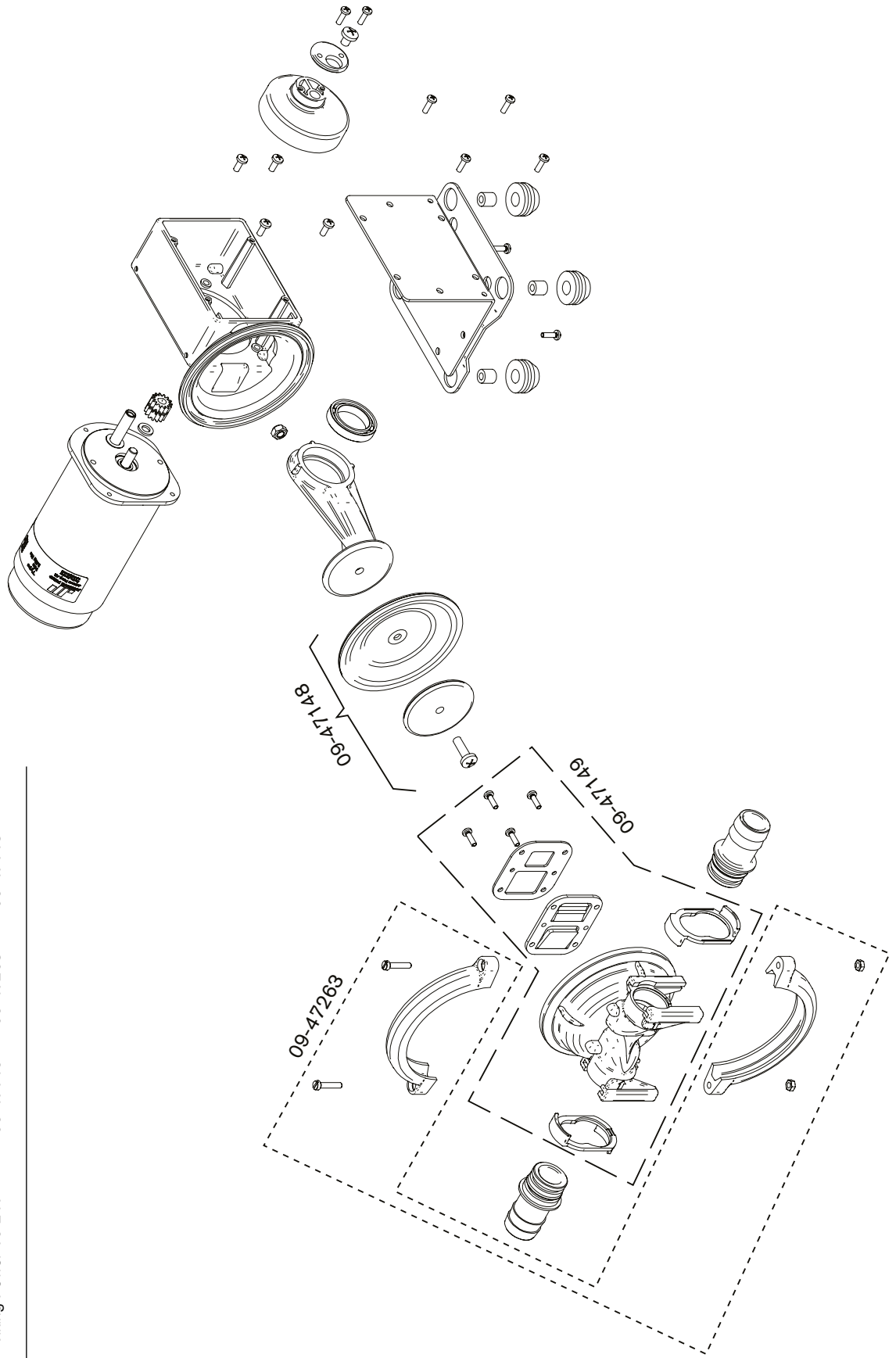

Viking Power 32

Part no. kit	Pump type	Body cpl	Clamp kit	Diaphragm
10-13373-01/-03	Viking Power 32 12V	09-47182	09-47264	09-47181
10-13373-02/-04	Viking Power 32 24V	09-47182	09-47264	09-47181

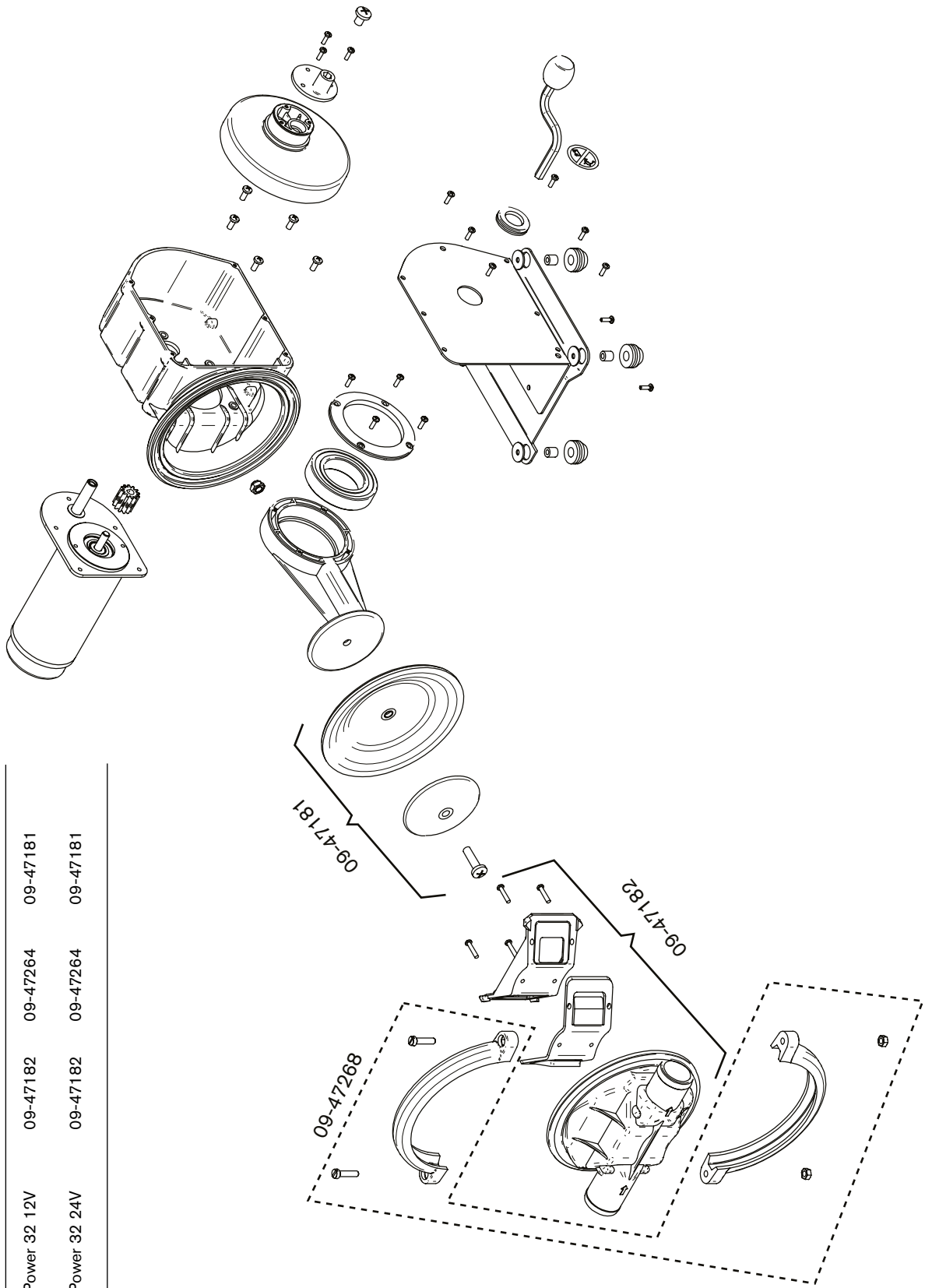

Viking Power Vacuum

Part no. kit	Pump type	Body cpl	Clamp kit	Diaphragm
10-13373-05/-07	Viking Power Vacuum 12V	09-47183	09-47264	09-47181
10-13373-06/-08	Viking Power Vacuum 24V	09-47183	09-47264	09-47181

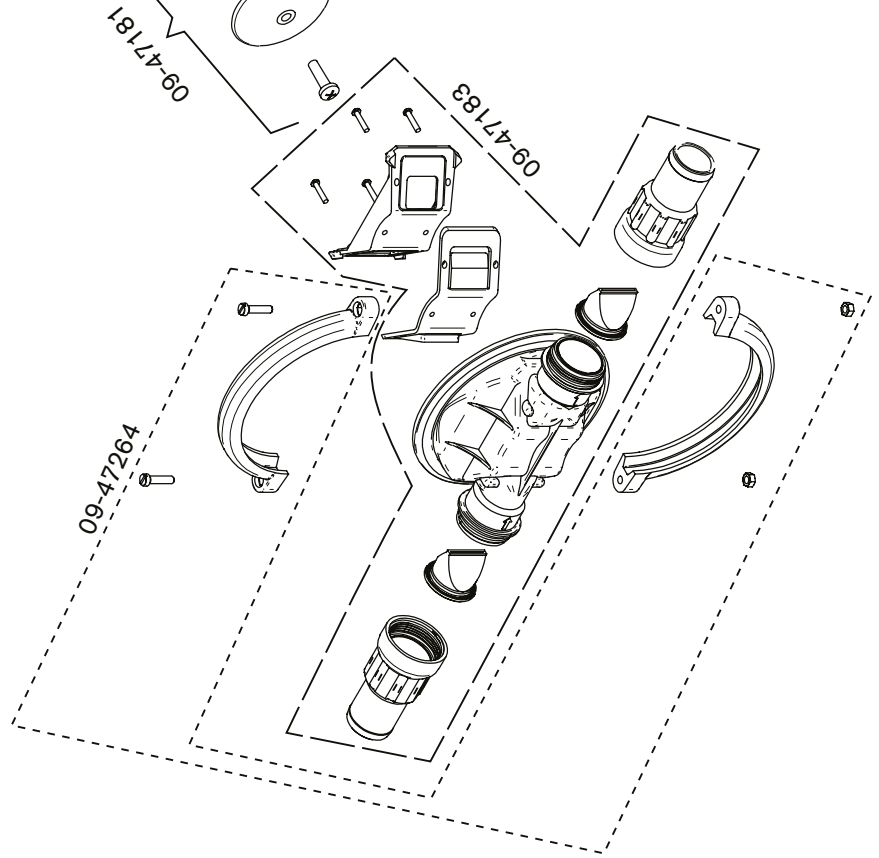
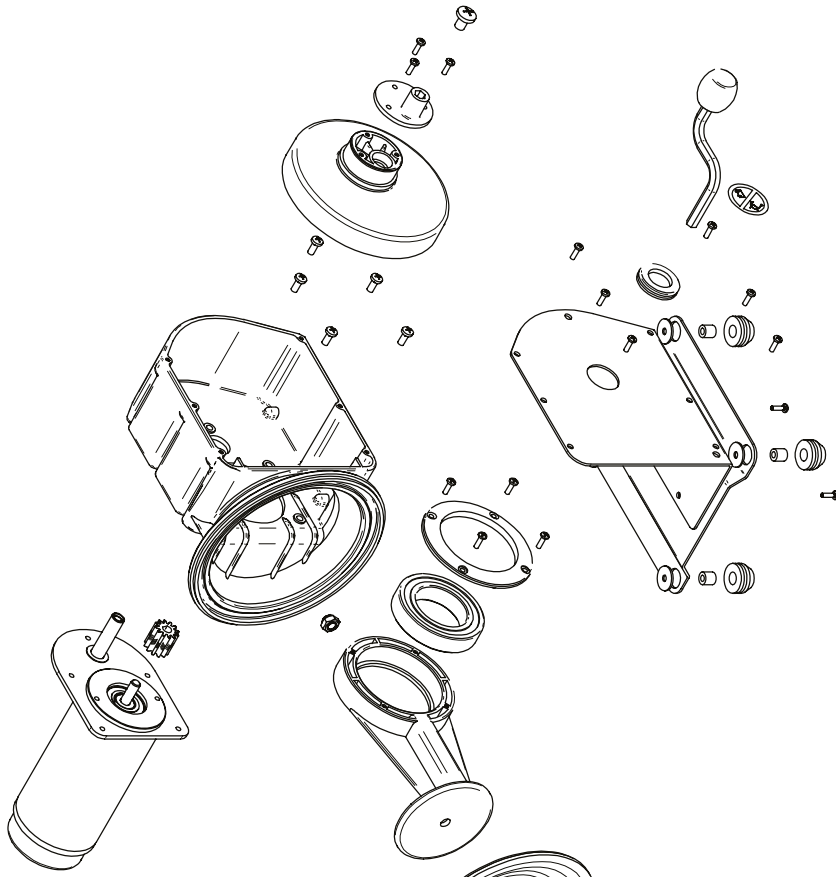

Aquat Marine Toilet Manual Comfort And Compact

Part no.	Toilet type	1 Wooden seat	2 Bowl	3 Intake elbow	4 Gasket kit	5 Outlet elbow	6 Plastic base	7 Hinge set	8 Base gasket kit	9 Flush handle kit	10 Handle kit	11 Pump ass'y
80-47229-01	Compact, manual	81-47241-01	81-47245-01	81-47246-01	81-47242-01	81-47246-02	81-47243-01	81-47267-01	81-47268-01	81-47269-01	81-47244-01	81-47239-01
80-47230-01	Comfort, manual	81-47241-02	81-47245-02	81-47246-01	81-47242-01	81-47246-02	81-47243-01	81-47267-01	81-47268-01	81-47269-01	81-47244-01	81-47239-01

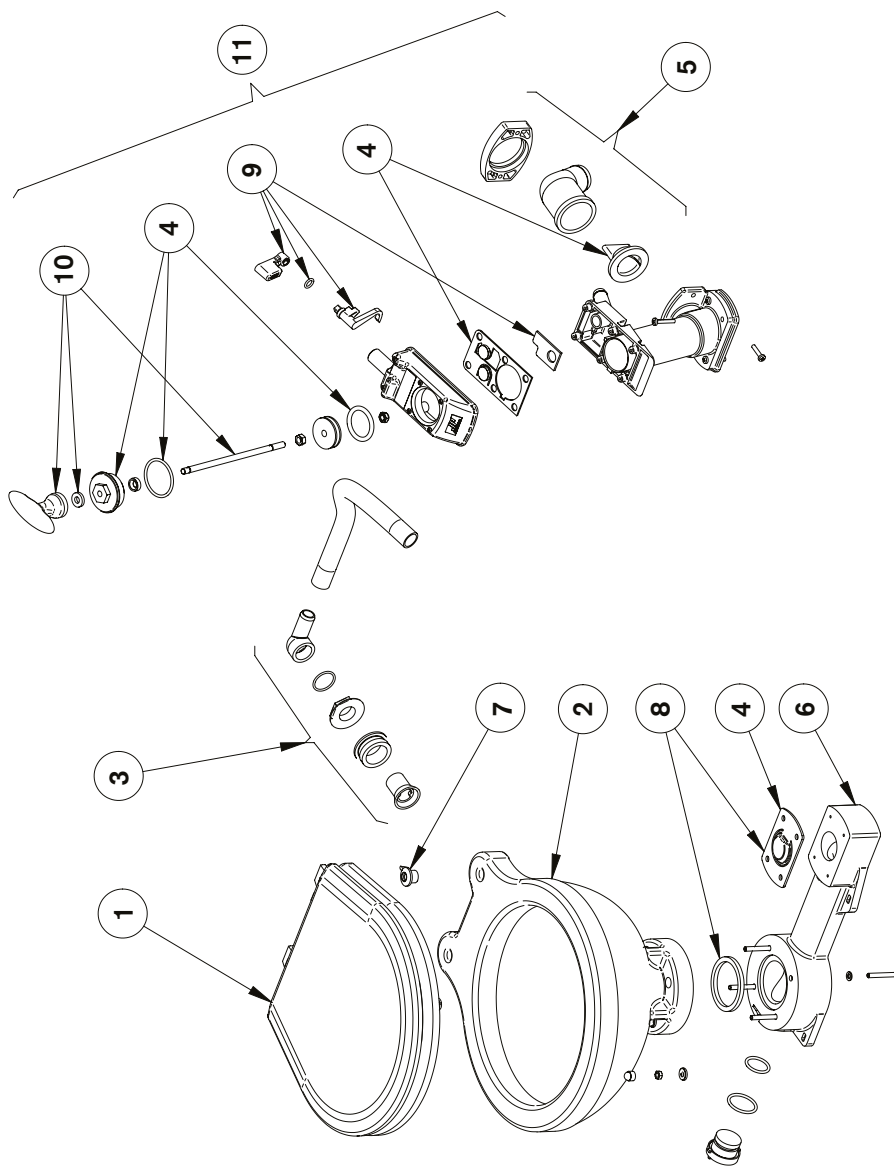

Aquat Marine Toilet Silent Electric And Premium

Part no.	Toilet type	1 Wooden seat	2 Bowl	3 Outlet elbow	4 Intake elbox	5 Bowl gasket	6 Hinge set	7 Base group	8 Motor group	9 Flush pump/ solenoid valve	10 Control panel	11 Conversion kit	12 Motor cover
80-47231-01	Compact 12V	81-47241-01	81-47245-01	81-47273-01	81-47246-01	81-47274-01	81-47267-01	81-47247-01	81-47248-01	10-24677-01	81-36105-01	81-47240-01	81-47302-01
80-47231-02	Compact 24V	81-47241-01	81-47245-01	81-47273-01	81-47246-01	81-47274-01	81-47267-01	81-47247-01	81-47248-02	10-24677-02	81-36105-01	81-47240-02	81-47302-01
80-47232-01	Comfort 12V	81-47241-02	81-47245-02	81-47273-01	81-47246-01	81-47274-01	81-47267-01	81-47247-01	81-47248-01	10-24677-01	81-36105-01	81-47240-01	81-47302-01
80-47232-02	Comfort 24V	81-47241-02	81-47245-02	81-47273-01	81-47246-01	81-47274-01	81-47267-01	81-47247-01	81-47248-02	10-24677-02	81-36105-01	81-47240-02	81-47302-01
80-47233-01	Premium Low 12V	81-47241-02	81-47245-03	81-47273-01	81-47246-03	81-47274-01	81-47267-01	81-47247-01	81-47248-01	10-24677-01	81-36105-01	81-47240-01	-
80-47233-02	Premium Low 24V	81-47241-02	81-47245-03	81-47273-01	81-47246-03	81-47274-01	81-47267-01	81-47247-01	81-47248-02	10-24677-02	81-36105-01	81-47240-02	-
80-47234-01	Premium Low 12V, bevel.	81-47241-02	81-47245-04	81-47273-01	81-47246-03	81-47274-01	81-47267-01	81-47247-01	81-47248-01	10-24677-01	81-36105-01	81-47240-01	-
80-47234-02	Premium Low 24V, bevel.	81-47241-02	81-47245-04	81-47273-01	81-47246-03	81-47274-01	81-47267-01	81-47247-01	81-47248-02	10-24677-02	81-36105-01	81-47240-02	-
80-47234-03	Premium Low 12V, bevel, solenoid	81-47241-02	81-47245-04	81-47273-01	81-47246-03	81-47274-01	81-47267-01	81-47247-01	81-47248-01	81-47301-01	81-36105-01	81-47240-01	-
80-47234-04	Premium Low 24V, bevel, solenoid	81-47241-02	81-47245-04	81-47273-01	81-47246-03	81-47274-01	81-47267-01	81-47247-01	81-47248-02	81-47301-02	81-36105-01	81-47240-02	-
80-47235-01	Premium Std. 12V	81-47241-02	81-47245-05	81-47273-01	81-47246-03	81-47274-01	81-47267-01	81-47247-01	81-47248-01	10-24677-01	81-36105-01	81-47240-01	-
80-47235-02	Premium Std. 24V	81-47241-02	81-47245-05	81-47273-01	81-47246-03	81-47274-01	81-47267-01	81-47247-01	81-47248-02	10-24677-02	81-36105-01	81-47240-02	-
80-47236-01	Premium Std. 12V, bevel.	81-47241-02	81-47245-06	81-47273-01	81-47246-03	81-47274-01	81-47267-01	81-47247-01	81-47248-01	10-24677-01	81-36105-01	81-47240-01	-
80-47236-02	Premium Std. 24V, bevel.	81-47241-02	81-47245-06	81-47273-01	81-47246-03	81-47274-01	81-47267-01	81-47247-01	81-47248-02	10-24677-02	81-36105-01	81-47240-02	-

Aquat Marine Toilet Silent Electric And Premium

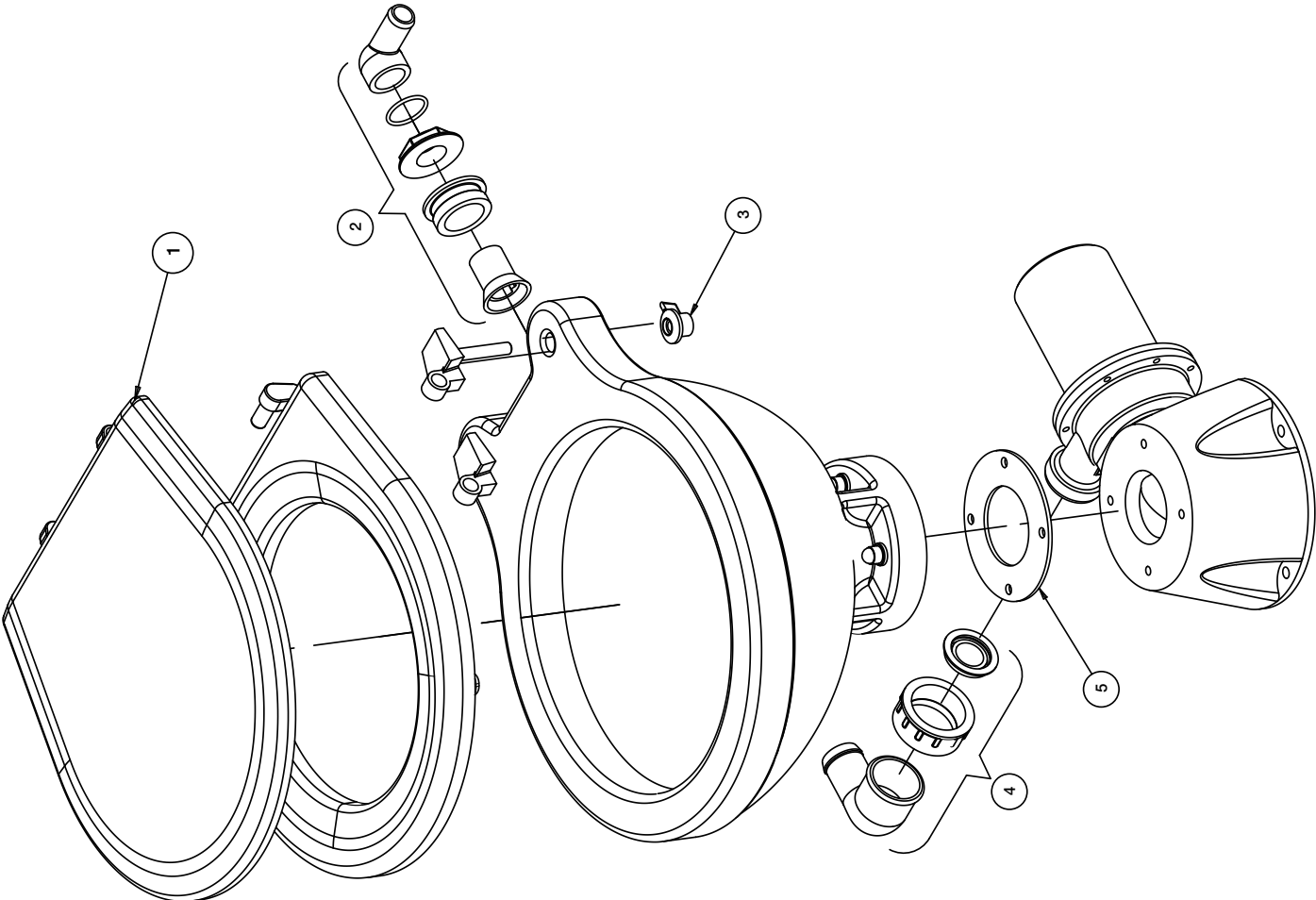

Bilge Pumps

Hand-Driven Bilge Pump Viking

Part no.	Pump type	1	2	3	4	5	6	7	8	8	9	10
		Mounting ring	Locking washer	Shaft 71 mm	Shaft 86 mm	Screw	Valve	O-ring	Inlet 1.1/2"	Inlet 1"	Screw	Cover
70-50005	Thrudeck 1.1/2"	74-50054	0.0357.001	74-50069	74-50068	0,0140.201	74-50062	0.2172.557	74-50052	74-50086	0.0140.202	74-50055
70-50007	Bulkhead 1.1/2"	74-50079	0.0357.001	74-50069	74-50068	0,0140.201	74-50062	0.2172.557	74-50052	74-50086	0.0140.202	74-50055
70-50025	Thrudeck 1"	74-50054	0.0357.001	74-50069	74-50068	0,0140.201	74-50062	0.2172.557	74-50052	74-50086	0.0140.202	74-50055
70-50027	Bulkhead 1"	74-50079	0.0357.001	74-50069	74-50068	0,0140.201	74-50062	0.2172.557	74-50052	74-50086	0.0140.202	74-50055

Part no.	Pump type	11	12	13	13	14	15	16	17	18	19	20
		O-ring	Pump body	Outlet 1.1/2"	Outlet 1"	Piston plate	Diaphragm	Piston	Handle	Pivot	Pivot	Sealing boat
70-50005	Thrudeck 1.1/2"	0.2172.647	74-50051	74-50053	74-50087	74-50057	74-50063	74-50056	74-50067	74-50066	-	74-50075
70-50007	Bulkhead 1.1/2"	0.2172.647	74-50051	74-50053	74-50087	74-50057	74-50063	74-50056	74-50067	-	74-50077	-
70-50025	Thrudeck 1"	0.2172.647	74-50051	74-50053	74-50087	74-50057	74-50063	74-50056	74-50067	74-50066	-	74-50075
70-50027	Bulkhead 1"	0.2172.647	74-50051	74-50053	74-50087	74-50057	74-50063	74-50056	74-50067	-	74-50077	-

Part no.	Pump type	21	22
		Cover plate	Screw
70-50005	Thrudeck 1.1/2"	74-50078	0.0279.302
70-50007	Bulkhead 1.1/2"	-	-
70-50025	Thrudeck 1"	74-50078	0.0279.302
70-50027	Bulkhead 1"	-	-

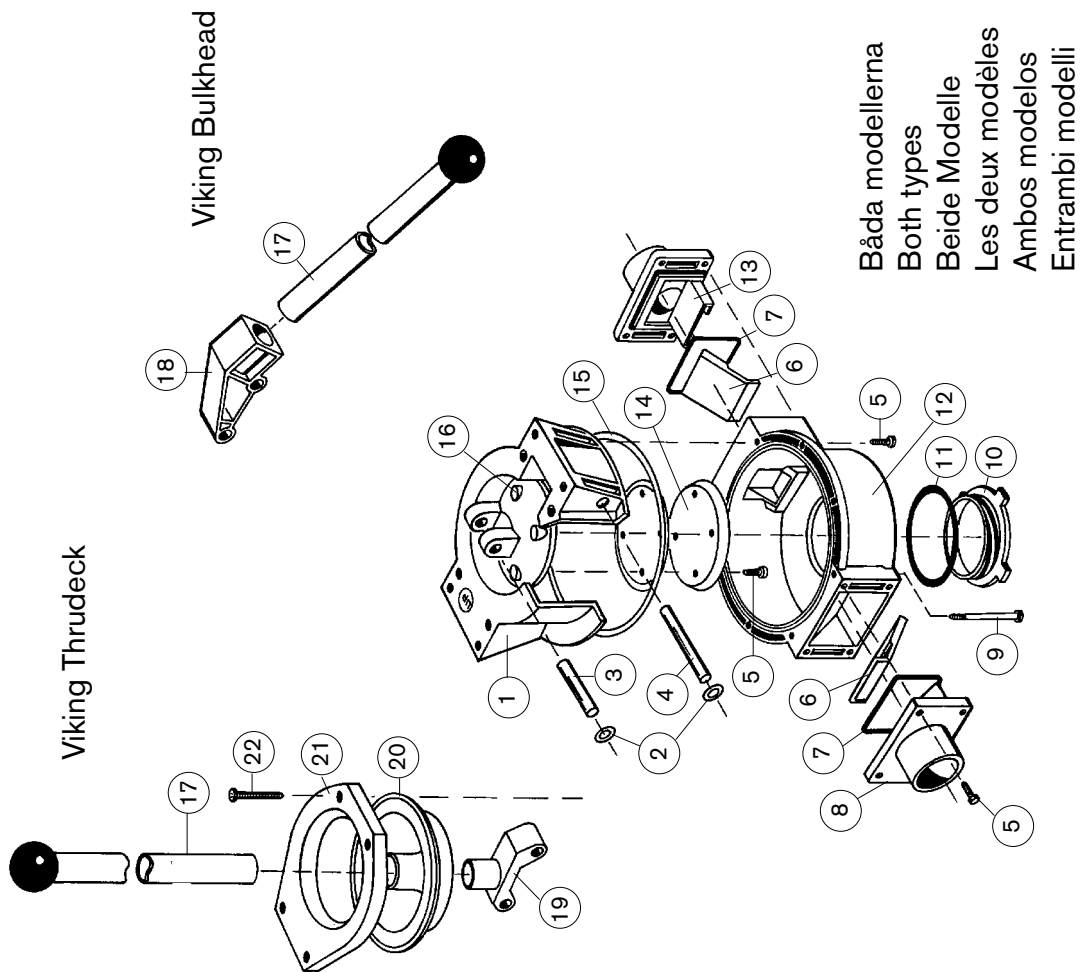

Circulating Pumps

Circulating Pumps - CM10P7-1 and CM30P7-1

Part no.	Pump type	1 Body cpl	2 Impeller cpl	5 Motor bracket cpl	8 Joint	9 Magnet housing
10-24501-03	CM10P7-1 12 V Dia 16	09-46549	09-46551	36-503-023	01-46552	01-35733
10-24501-04	CM10P7-1 24 V Dia 16	09-46549	09-46551	36-503-023	01-46552	01-35733
10-24502-03	CM10P7-1 12 V Dia 20	09-46550	09-46551	36-503-023	01-46552	01-35733
10-24502-04	CM10P7-1 24 V Dia 20	09-46550	09-46551	36-503-023	01-46552	01-35733
10-24504-03	CM30P7-1 12 V Dia 20	09-46550	09-46551	36-503-023	01-46552	01-35733
10-24504-04	CM30P7-1 24 V Dia 20	09-46550	09-46551	36-503-023	01-46552	01-35733

Body cpl includes body (1), o-ring (pos 3) and 4 screws (pos 4)

Impeller cpl includes impeller (pos 2), washer (pos 6) and shaft (pos 7)

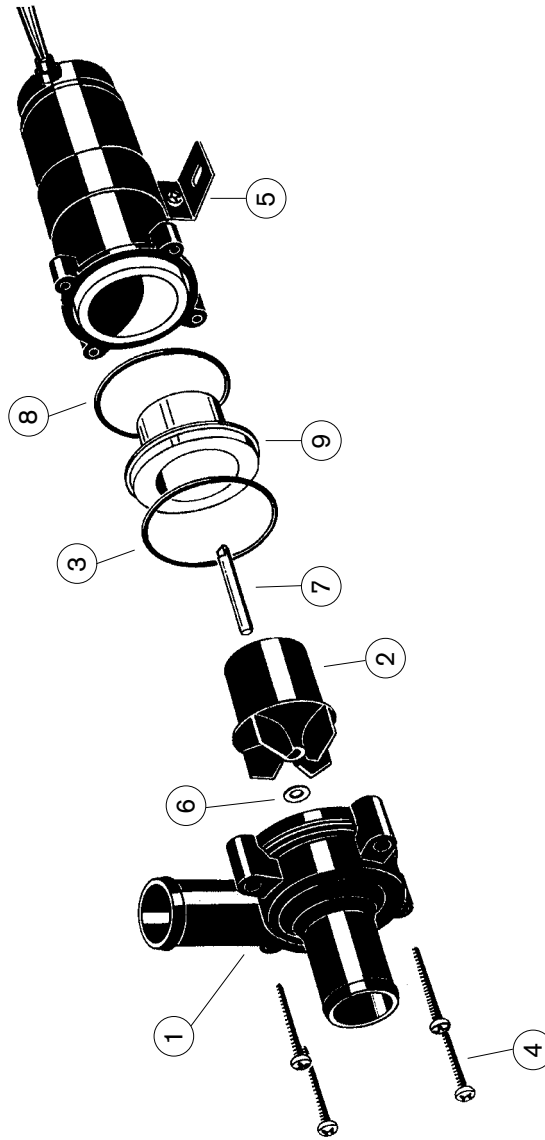

Circulating Pumps - CM90P7-1

Part no.	Pump type	A	Body cpl	11	Motor bracket cpl	9	O-ring	3	Magnet housing	6	Impeller	7	Screw	5	Middle part
10-24664-01	CM90P7-1 12V	09-24659	09-36049	09-36049	0.2173.099	01-36024	01-35162	01-45749	01-36027-1	Dia 38					
10-24664-02	CM90P7-1 24V	09-24659	09-36049	09-36049	0.2173.099	01-36024	01-35162	01-45749	01-36027-1	Dia 38					

Body cpl includes body (8), o-ring (pos 9) and 7 screws (pos 10)

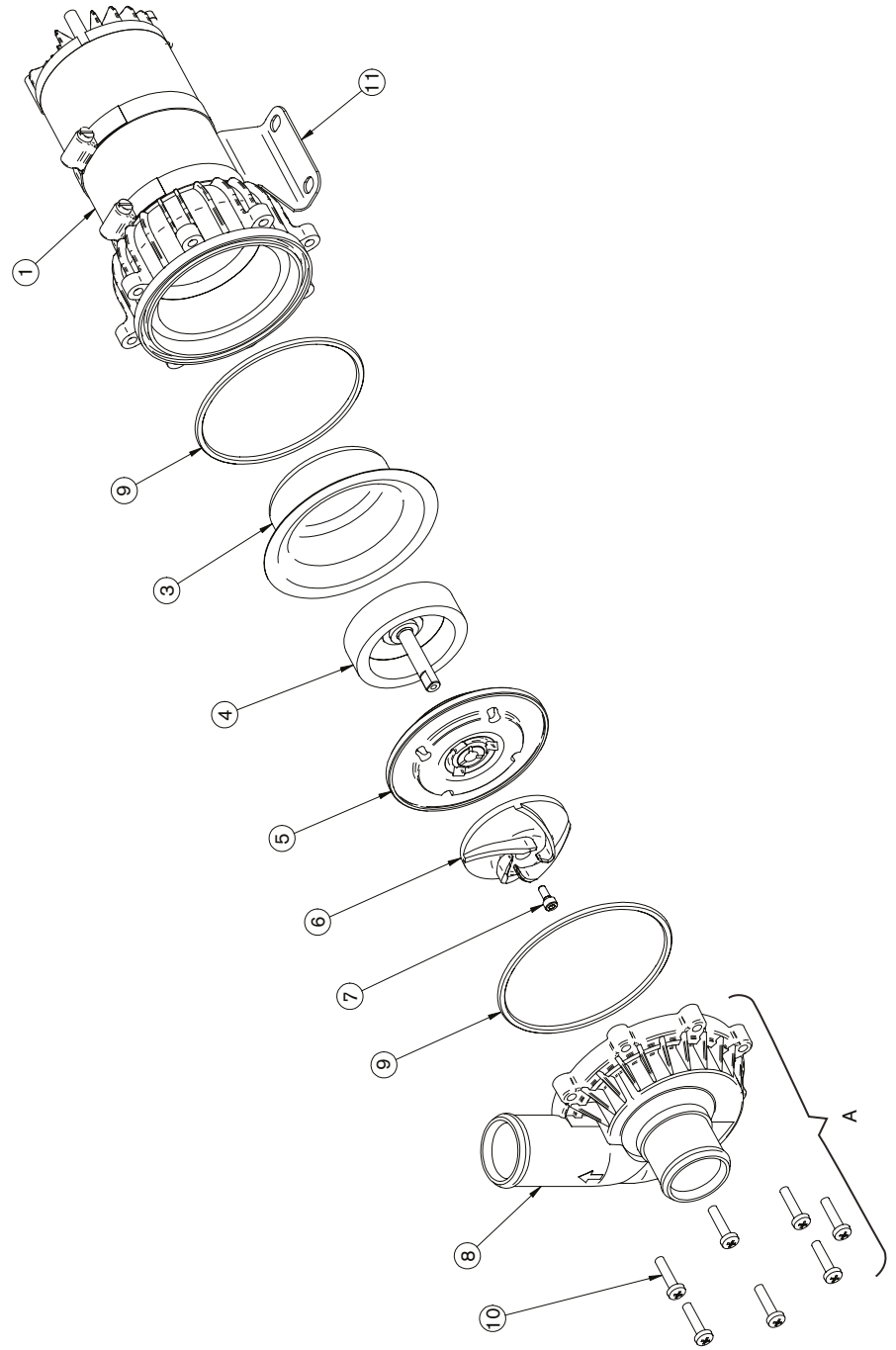

Circulating Pumps - C090P5-1

Part no.	Pump type	Body cpl	Flange	3 Mech seal	4 Middle part	5 O-ring	6 Impeller	7 Screw	8 Screw	9 Screw	10 Washer	11 Washer	12 Washer	13 Motor
10-24190-1	C090P5-1 12V	09-46283	01-24193	09-0.2247.010	01-24192	0.2173.457	01-35162	01-45749	0.0319.500	0.0278.037	01-45601	0.0350.115	0.0352.104	01-24537-01
10-24190-2	C090P5-1 24V	09-46283	01-24193	09-0.2247.010	01-24192	0.2173.457	01-35162	01-45749	0.0319.500	0.0278.037	01-45601	0.0350.115	0.0352.104	01-24537-02
10-24190-3	C090P5-1 32V	09-46283	01-24193	09-0.2247.010	01-24192	0.2173.457	01-35162	01-45749	0.0319.500	0.0278.037	01-45601	0.0350.115	0.0352.104	01-24537-03

Body cpl includes body (1), o-ring (pos 5) and 5 screws (pos 7)

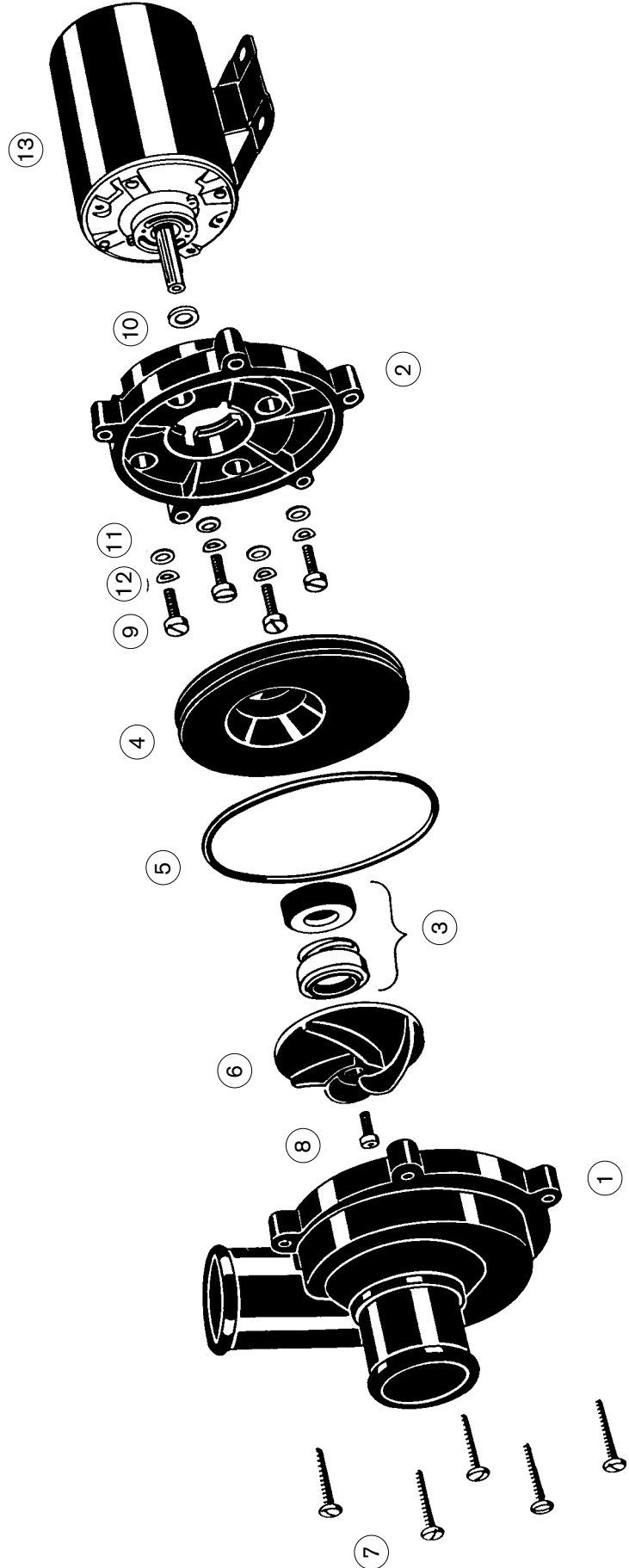



SPX FLOW TECHNOLOGY SWEDEN AB

Nastagatan 19, P.O. Box 1436
SE-701 14 Örebro, Sweden
P: +46 (0)19 21 83 00
F: +46 (0)19 27 23 72
E: johnson-pump.marine@spx.com

SPX reserves the right to incorporate our latest design and material changes without notice or obligation. Design features, materials of construction and dimensionals data, as described in this bulletin, are provided for your information only and should not be relied upon unless confirmed in writing.

Please contact your local sales representative for product availability in your region. For more information visit www.spx.com.

ISSUED 03/2009 JP-1400/02
COPYRIGHT ©2011 SPX Corporation

